

Rhinology (Nasal Speculas)

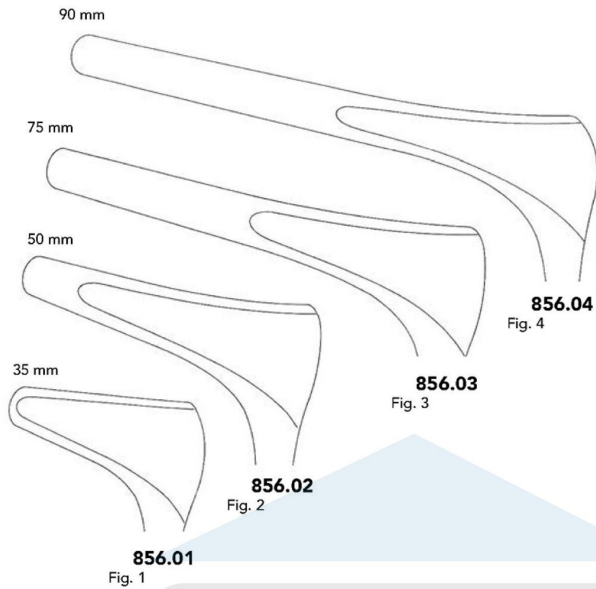

KILLIAN
14 cm/5½"



856.01
Fig. 1

856.02
Fig. 2

856.03
Fig. 3

856.04
Fig. 4



HARTMANN-HALLE
14 cm/5½"

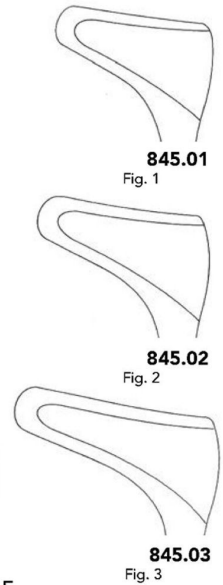

845.01
Fig. 1

845.02
Fig. 2

845.03
Fig. 3



COTTLE
15 cm/6"

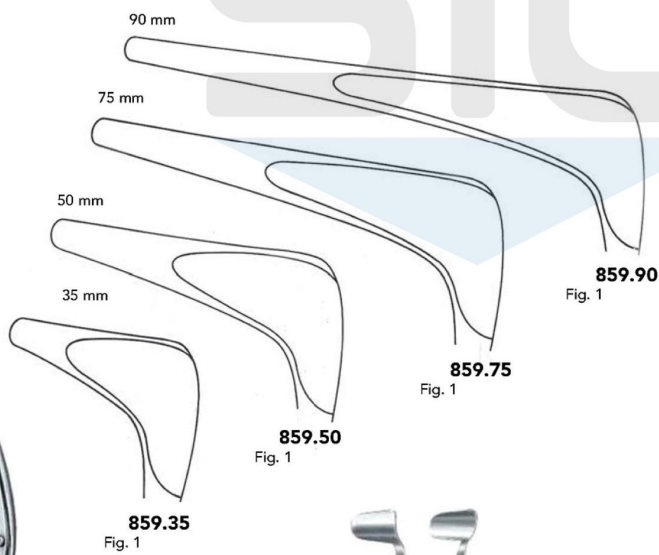

859.90
Fig. 1

859.75
Fig. 1

859.50
Fig. 1

859.35
Fig. 1



GOLDSMITH-THUDICHUM
Fig. Blades 6.5 cm/2½"

1	18.5 x 9.5 mm	817.01
2	21.0 x 10.5 mm	817.02
3	21.0 x 11.5 mm	817.03



TIECK-HALLE
852.13
13 cm/5"



VIENNA
858.14
14 cm/5½"

Rhinology (Nasal Speculas)

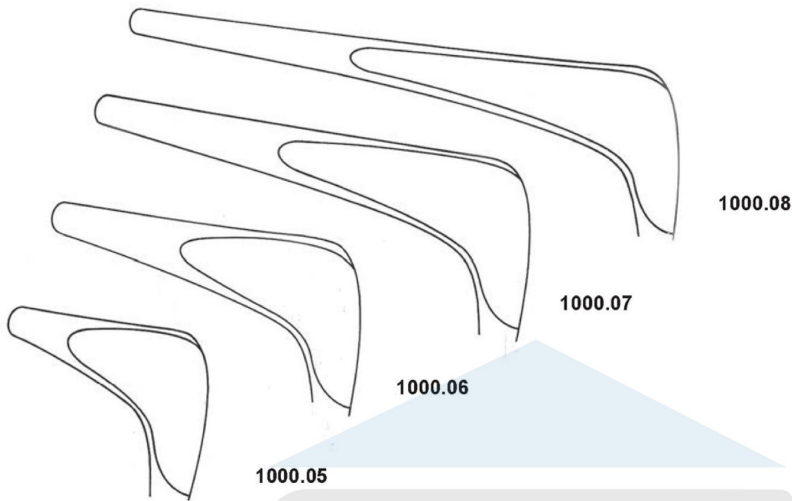

COTTLE
13.5 cm

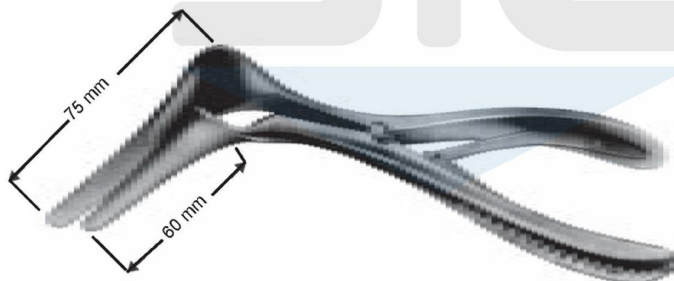

1000.09
Kisa sol bleyd,
Left blade shortened

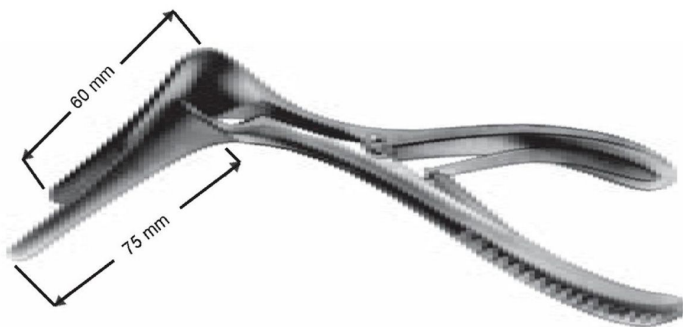

1000.10
Kisa sağ bleyd,
Right blade shortened

Rhinology (Nasal Tempon & Septum Forceps)

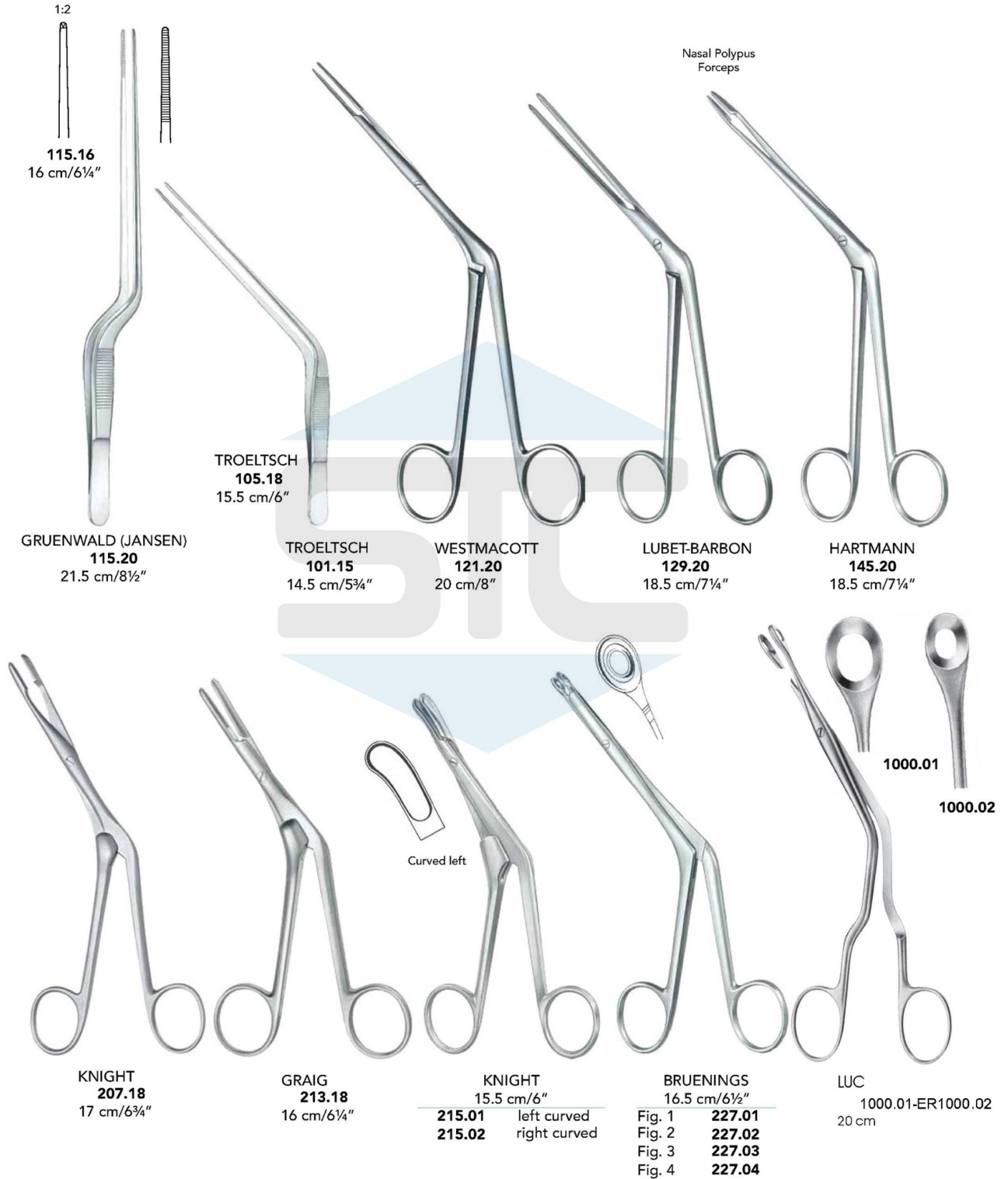

Rhinology (Ethmoid Bone Forceps, Nasal Cutting Forceps)

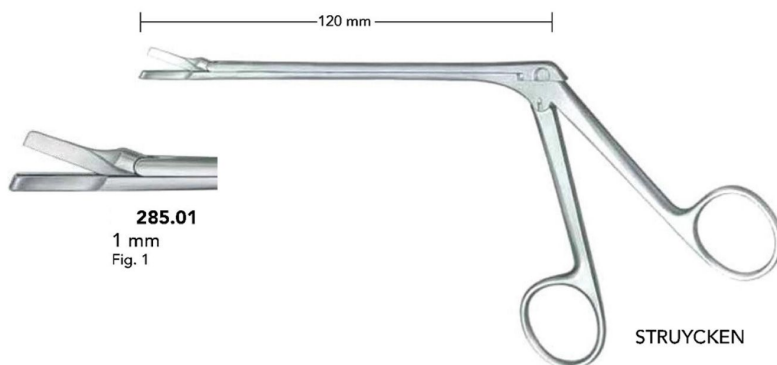
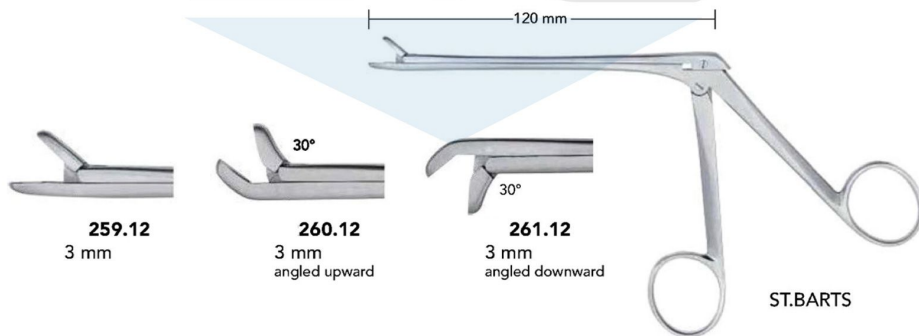
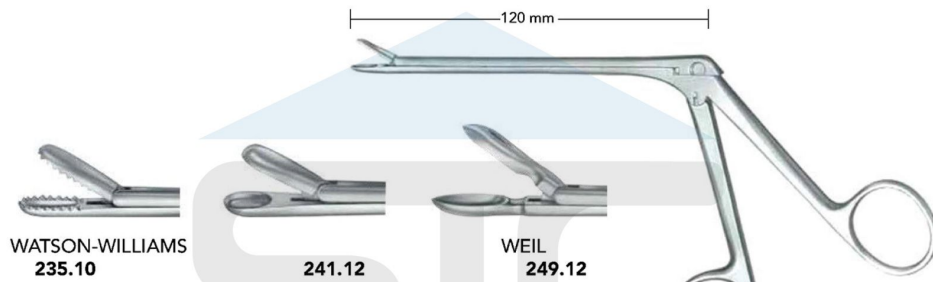
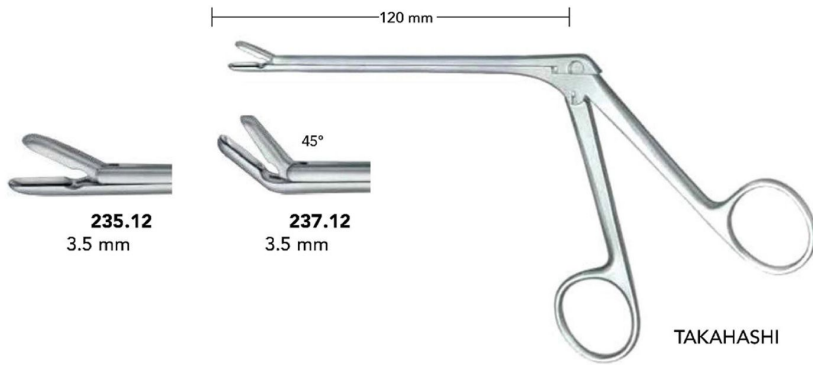

Rhinology (Nasal Cutting Forceps, Antrum Punches)

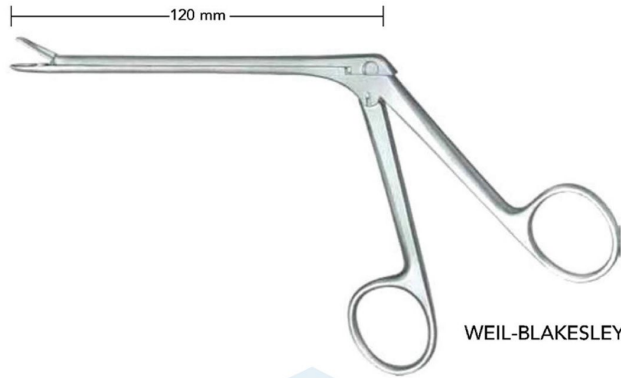

WEIL-BLAKESLEY

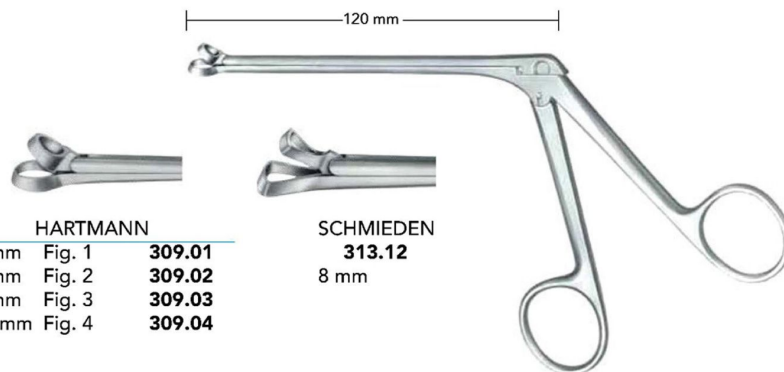
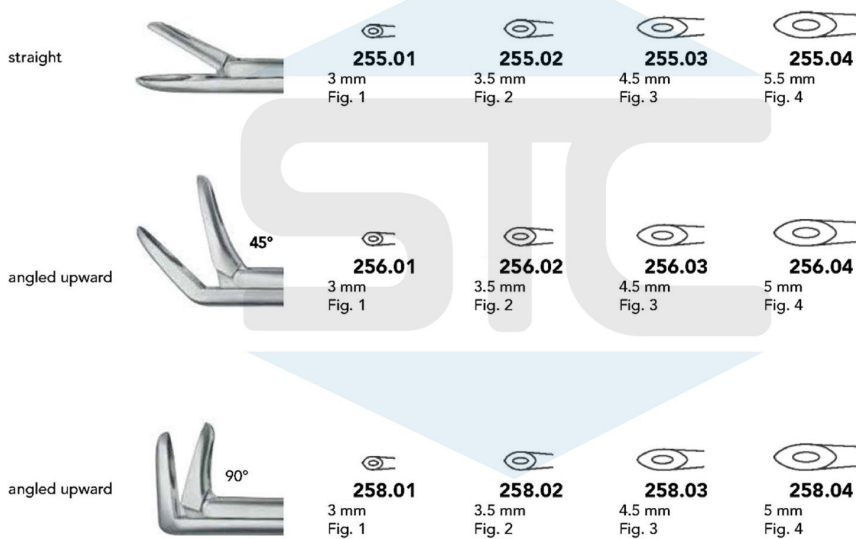

HARTMANN		
Ø 5 mm	Fig. 1	309.01
Ø 7 mm	Fig. 2	309.02
Ø 9 mm	Fig. 3	309.03
Ø 11 mm	Fig. 4	309.04

SCHMIEDEN	
	313.12
	8 mm

Rhinology (Sphenoid Bone Punches, Antrum Punches)

	90° upward cutting	90° downward cutting	40° downward cutting
3 mm	356.17	357.17	362.03
5 mm	360.17	361.17	362.05

FERRIS-SMITH-KERRISON

	straight	30° angled upward	30° angled downward
10 x 2 mm	364.02	365.02	367.02
10 x 3 mm	364.03	365.03	367.03
10 x 4 mm	364.04	365.04	367.04
10 x 5 mm	364.05	365.05	367.05
10 x 6 mm	364.06	365.06	367.06

KERRISON	
3 x 3 mm	389.00
4 x 4 mm	389.01
5 x 5 mm	389.02
6 x 6 mm	389.03

HAJEK	
90° upward cutting	342.12 3.5 mm
90° downward cutting	343.12 4 mm

Rhinology (Septum Forceps, Septum Morselizers)

through-cutting



MIDDLETON-JANSEN
323.19
20.5 cm/8¼"

one toothed cutting edge



MIDDLETON-JANSEN
327.19
20 cm/8"



CAPLAN
331.20
20 cm/8"

TC Jaws



334.21
20 cm/8"



RUBIN
335.20
20 cm/8"



RUBIN
335.21
18.5 cm/7¼"

TC Jaws



RUBIN
337.21
18.5 cm/7¼"

Protection Cap



335.01

Rhinology (Rhinoplasty & Septum Knives, Swivel Knives)

Mucosa Knife

JOSEPH 15 cm/6"	FOMON 444.16 16.5 cm/6½"	CONVERSE 459.16 16 cm/6¼"	JOSEPH 466.15 15.5 cm/6"	COTTLE 468.15 14 cm/5½"	FREER 484.15 16.5 cm/6½"	FREER 497.19 19 cm/7½"	FREER 499.19 18.5 cm/7¼"
Fig. 1 440.01							
Fig. 2 440.02							

Septum Elevators

Septum Elevators

3.5 mm

4 mm

Cleft Palate Periosteal Raspatory

544.01
24.5 cm/9½"

544.02
24.5 cm/9½"







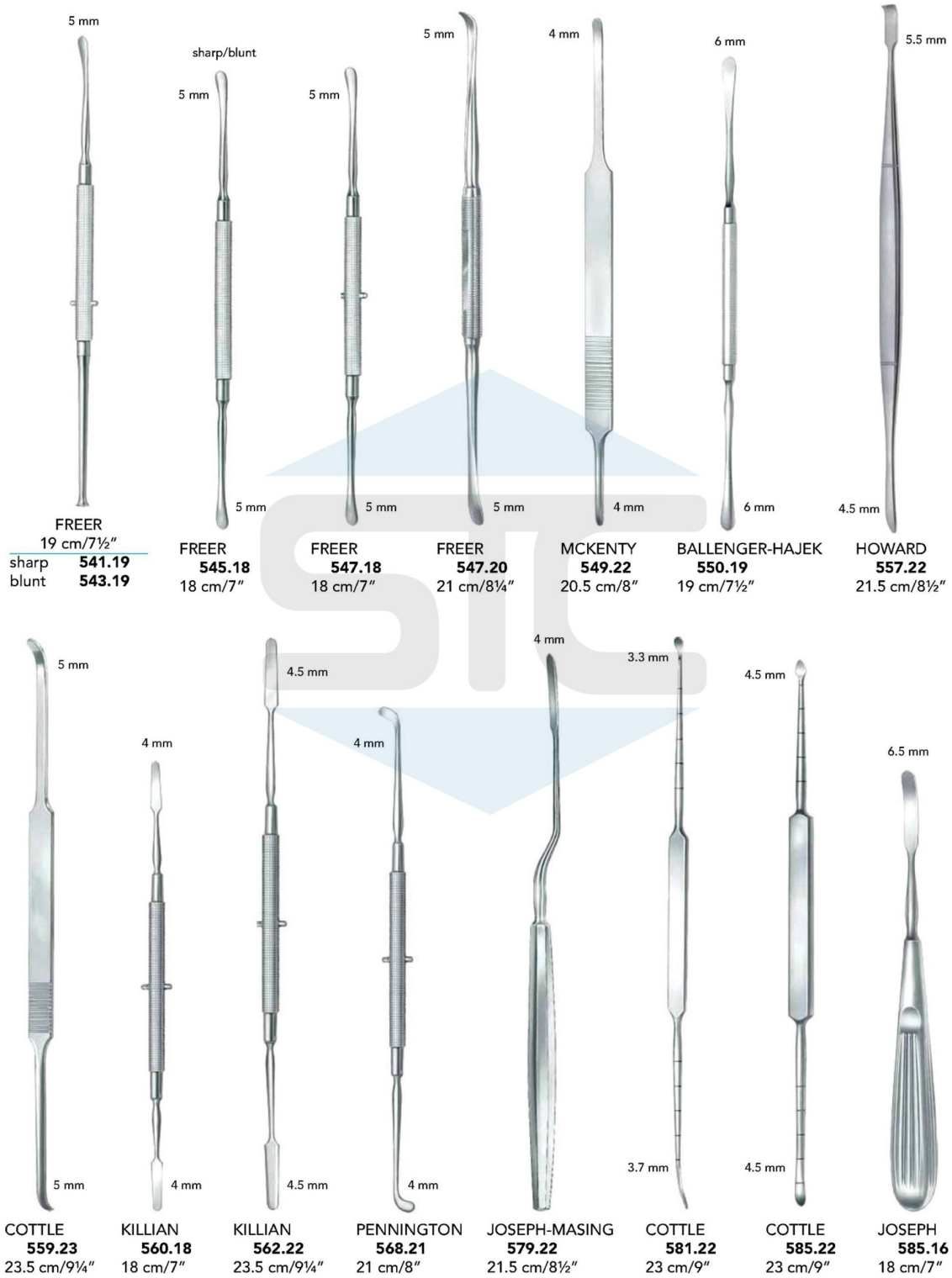



KRENKEL

BALLENGER 21 cm/8¼"	BALLENGER 21 cm/8¼"	MCKENTY 15 cm/6"	HALLE 525.16 16 cm/6¼"	JOSEPH 531.16 16.5 cm/6½"
3 mm 504.03	3 mm 505.03	4 mm 521.04		
4 mm 504.04	4 mm 505.04	5 mm 521.05		
5 mm 504.05	5 mm 505.05			

Rhinology (Septum Elevators, Periosteal Elevators)



Rhinology (Septum Elevators, Periosteal Elevators)

						
FREER 593.16 16.5 cm/6½"	FREER 595.15 16 cm/6¼"	BALLENGER 15 cm/6"	KILLIAN 601.16 16 cm/6¼"	KILLIAN-CLAUS 605.16 16 cm/6¼"	COTTLE 18.5 cm/7¼"	COTTLE 18.5 cm/7¼"
		2 mm 597.02 4 mm 597.04 6 mm 597.06 8 mm 597.08			4 mm 606.04 7 mm 606.07 9 mm 606.09 12 mm 606.12	2 mm 608.02 4 mm 608.04 7 mm 608.07 9 mm 608.09 12 mm 608.12
						
COTTLE 607.06 18.5 cm/7¼"	COTTLE 609.06 18.5 cm/7¼"	COTTLE 610.16 18.5 cm/7¼"	COTTLE 612.16 18.5 cm/7¼"	RUBIN 18.5 cm/7¼"	WALTER 19 cm/7½"	WALTER 19 cm/7½"
				10 mm 616.10 12 mm 616.12 14 mm 616.14	3.0 mm 620.03 4.5 mm 620.04	3 mm 622.03 4 mm 622.04 7 mm 622.07 9 mm 622.09 12 mm 622.12

Rhinology (Rhinoplasty Chisels, Chisels)

FOMON
16 cm/6¼"

4 mm	623.04
5 mm	623.05
6 mm	623.06
7 mm	623.07

CINELLI
16 cm/6¼"

10 mm	624.10
12 mm	624.12
14 mm	624.14
16 mm	624.16

NEIVERT-ANDERSON
20.5 cm/8"

Right 7 mm **625.01**
Left 7 mm **625.02**
7 mm Straight **625.03**

LUCAS
1000.02 3 mm
1000.03 5 mm
Gujjar/Gouges 16 cm

SILVER 628.01 18 cm/7"
SILVER 628.02 18 cm/7"
SILVER 628.03 18 cm/7"

PARKES
629.01
16 cm/6¼"

JOSEPH
632.20
17 cm/6¾"

JOSEPH
634.20
17 cm/6¾"

JOSEPH
649.00
19 cm/7½"

ER649.02

Nasal Saws
angled, left
angled, right
40 mm working length
angled, left
angled, right

Rhinology (Nasal Rasps, Bone Files, Antrum Rasps)

MALTZ
34 x 7 mm
17 cm/6¾"
drawing cut **656.01**
pushing cut **656.02**

JOSEPH
60 x 8 mm
658.01
16 cm/6¼"

GALLAHER
17 cm/6¾"

669.01
45 x 6 mm

669.02
45 x 6 mm

669.03
45 x 6 mm

Cartilage Crusher

COTTLE
34 x 8 mm
670.21
21 cm/8¼"

COTTLE
652.00
12 cm/4¾"

AUFRICHT
32 x 9 mm
21 cm/8¼"
drawing cut **671.21**
pushing cut **673.21**

LEWIS
15 x 8 mm
19 cm/7½"
drawing cut **674.18**
pushing cut **676.18**

FOMON
680.21
20.5 cm/8"

FOMON
1/2
1000.03
21.5 cm

FOMON
1/2
1000.04
21.5 cm

6.5 mm

6.5 mm

7.5 mm

7.5 mm

Rhinology (Nasal Raspas - TC Jaws)



MALTZ
21 cm/8¼"



680.01
Fig. 1



680.02
Fig. 2

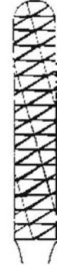

680.03
Fig. 3



680.04
Fig. 4



680.05
Fig. 5

TC Jaws

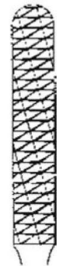

680.06
Fig. 6



680.07
Fig. 7



680.08
Fig. 8



680.09
Fig. 9



680.10
Fig. 10

TC Jaws

TC Jaws



FOMON
20.5 cm/8"

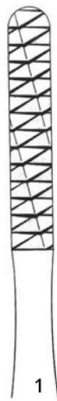

682.01
40 x 7 mm



682.03
40 x 7 mm



682.05
40 x 7 mm



682.07
40 x 7 mm



682.09
40 x 7 mm



682.52
40 x 7 mm

special size

Rhinology (Nasal Hooklets, Alar & Mucosa Hooklet)

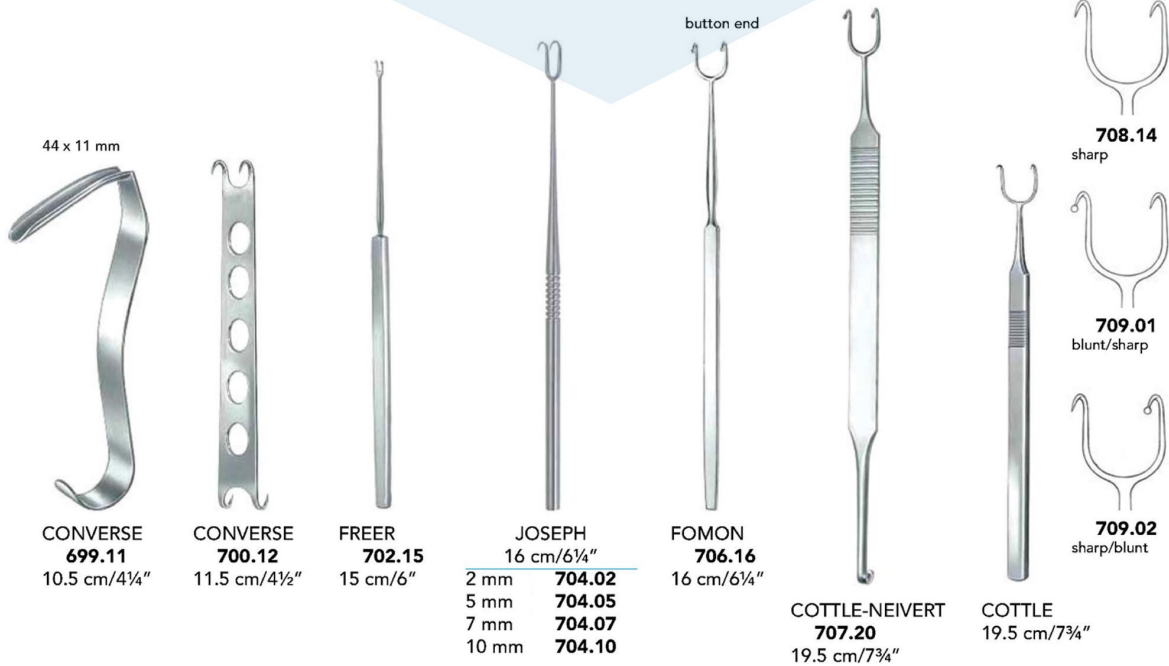
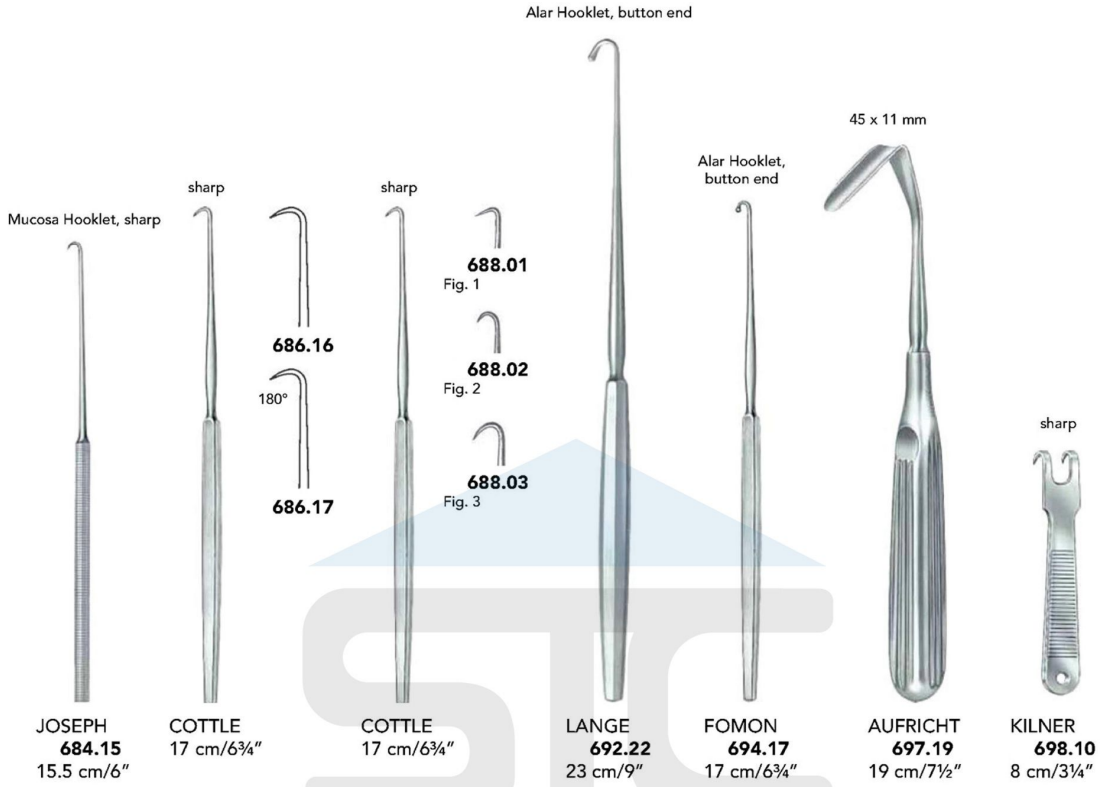

Rhinology (Nasal Retractors)

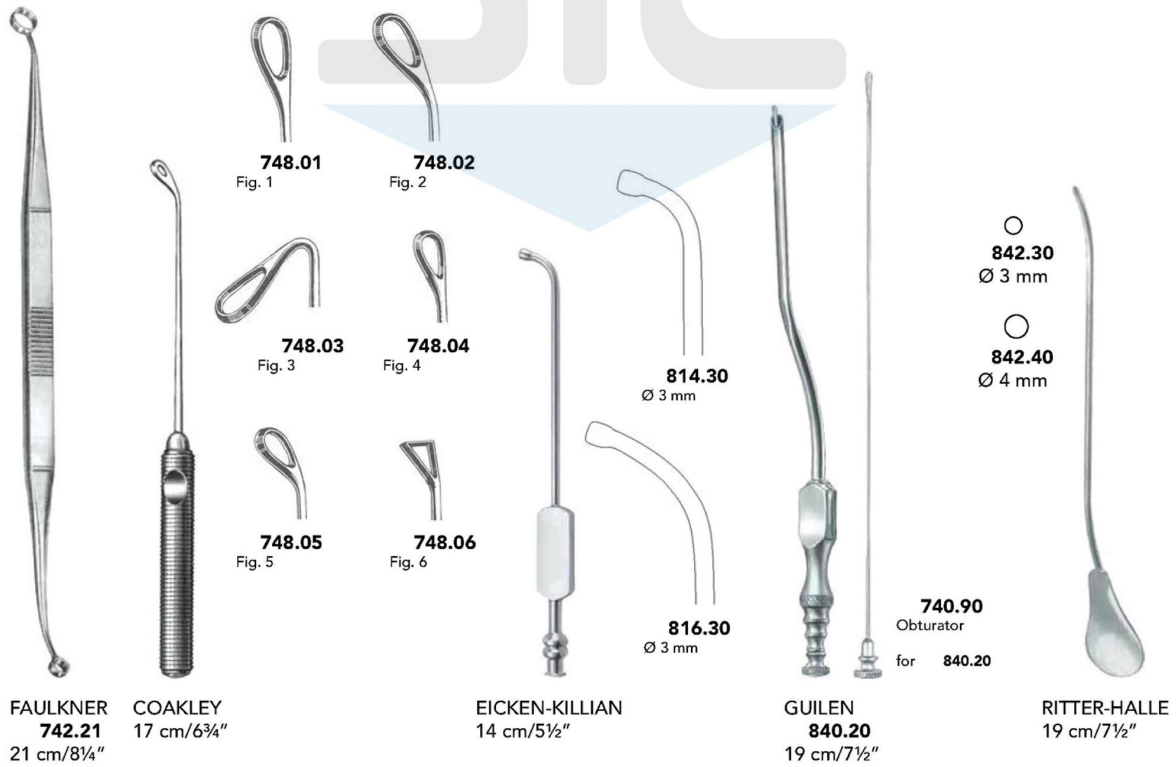
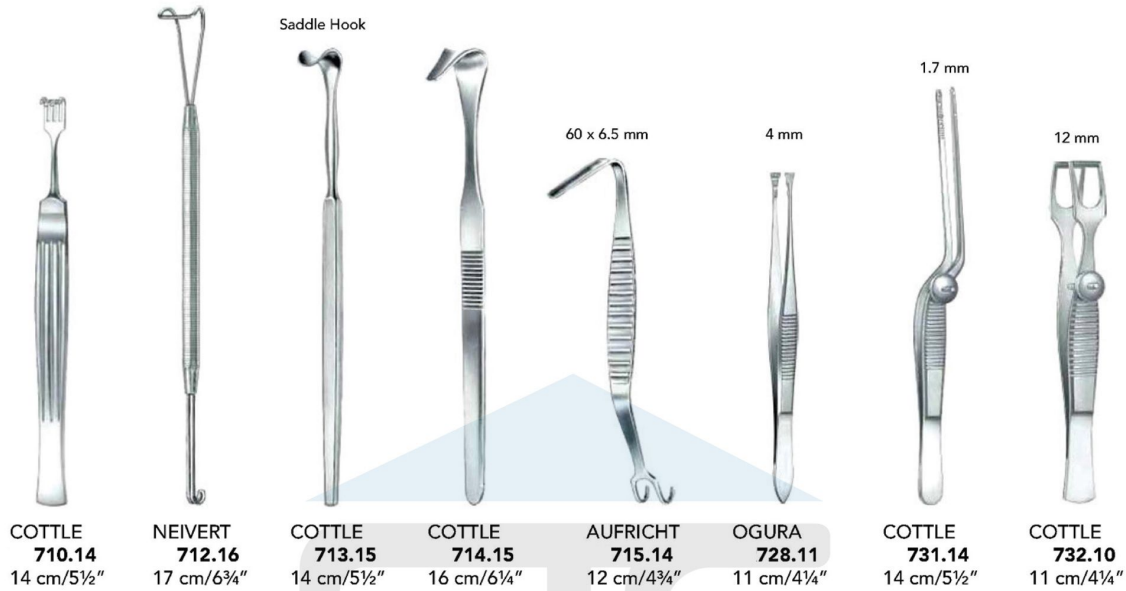

Rhinology (Septum Straightening Forceps)



Rhinology (Adenoid Currettes)

