

**Larynx & Tonsils (Tonsil Knife, Dissctors & Gauze Packers)**

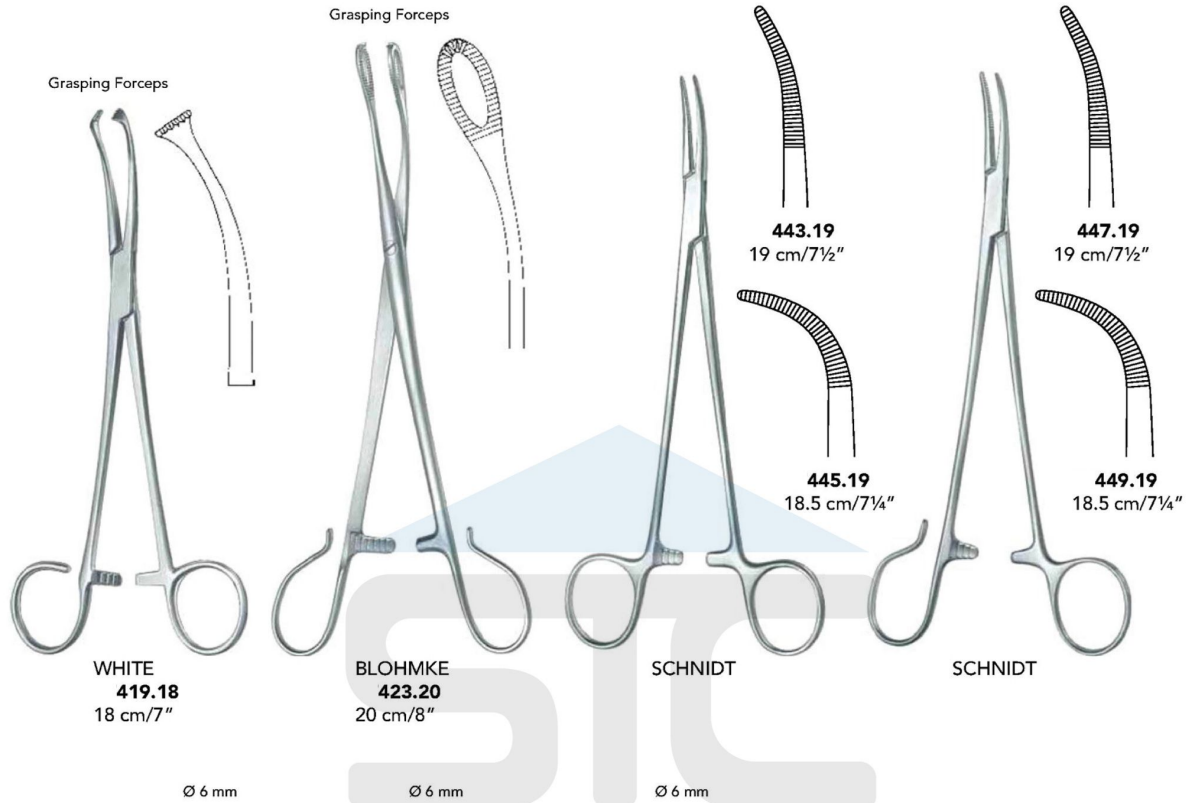

**Larynx & Tonsils (Tonsil Forceps & Tonsil Snare)**



**EVES**  
500.28  
28.5 cm/11¼"



**EVES**  
502.28  
28.5 cm/11¼"



**BRUENINGS**  
506.28  
29 cm/11½"

Wire Loop, package of 100 pieces

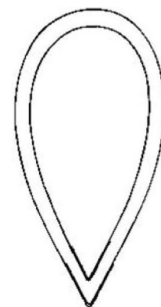

Ø 40 x 0.3 mm **511.40**  
Ø 50 x 0.3 mm **511.50**

**Larynx & Tonsils (Broncho-Esophagoscopy Forceps)**

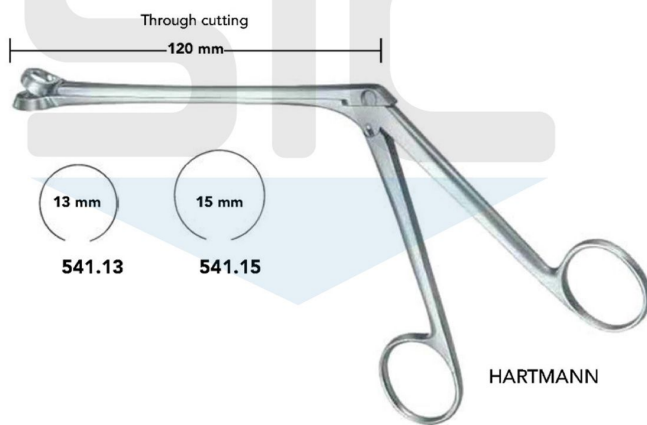
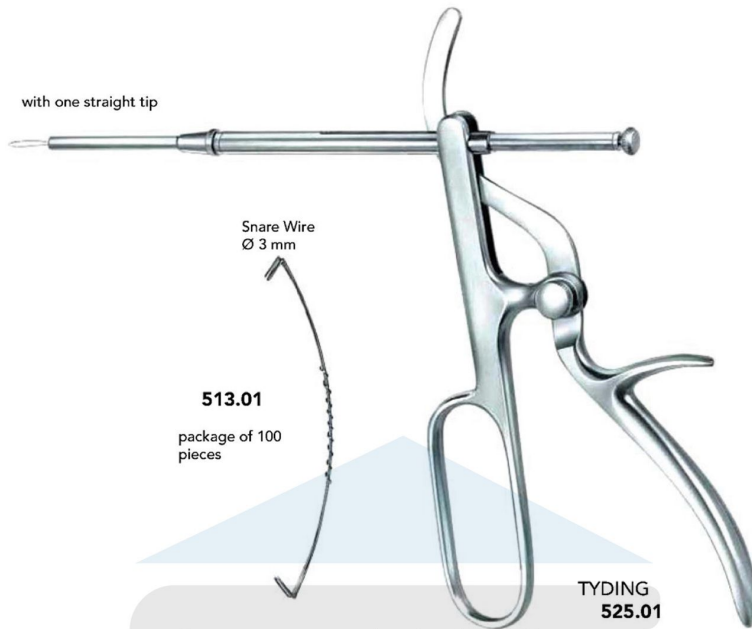

| BRÜNINGS   |               |
|------------|---------------|
| 22 cm/8¾"  | <b>584.20</b> |
| 32 cm/12¾" | <b>584.30</b> |
| 41 cm/16¼" | <b>584.40</b> |

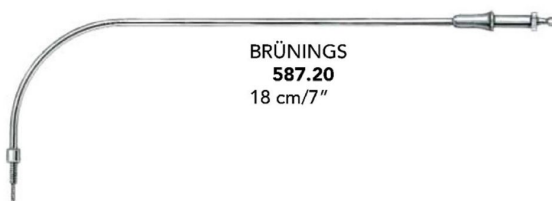

**Larynx & Tonsils (Exchangeable Tips)**



**FRAENKEL**  
**600.01**



**SEIFFERT**  
**604.01**



**FRAENKEL**  
**608.01**



**SCHEINMANN**  
**611.01**



**SCHEINMANN**  
**613.01**



**BRUENINGS**  
Fig. 2 **616.02**  
Fig. 3 **616.03**



**BRUENINGS**  
Fig. 2 **618.02**  
Fig. 3 **618.03**



**LANGE**  
**624.01**



**KRAUSE**  
Fig. 1 **628.01**  
Fig. 2 **628.02**



**KRAUSE**  
**632.01**



**CORDES**  
Fig. 1 **637.01**  
Fig. 2 **637.02**  
Fig. 3 **637.03**  
Fig. 4 **637.04**



**SCHUMACHER**  
**639.01**



**CORDES**  
Fig. 1 **643.01**  
Fig. 2 **643.02**



**CORDES**  
**647.01**



**ROSENBERG**  
**657.01**

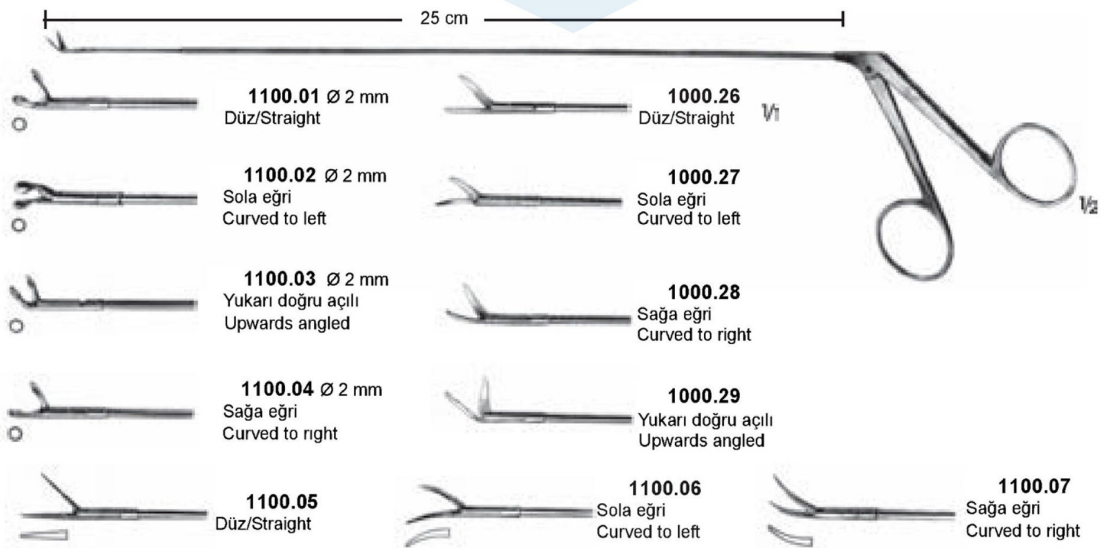

**Larynx & Tonsils (Laryngeal Mirrors)**



**MICHEL**  
27 cm/7½"

| Fig. | Ø     | Price  |
|------|-------|--------|
| 1    | 12 mm | 789.12 |
| 2    | 14 mm | 789.14 |
| 3    | 16 mm | 789.16 |
| 4    | 18 mm | 789.18 |



**794.11**  
11 cm/4¼"



**798.12**  
12.5 cm/5"

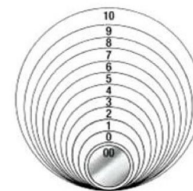
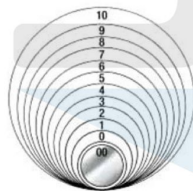

plane, with fixed handle



18.5 cm/7¼"

|         |         |        |
|---------|---------|--------|
| Fig. 00 | Ø 8 mm  | 781.08 |
| Fig. 0  | Ø 10 mm | 781.10 |
| Fig. 1  | Ø 12 mm | 781.12 |
| Fig. 2  | Ø 14 mm | 781.14 |
| Fig. 3  | Ø 16 mm | 781.16 |
| Fig. 4  | Ø 18 mm | 781.18 |
| Fig. 5  | Ø 20 mm | 781.20 |
| Fig. 6  | Ø 22 mm | 781.22 |
| Fig. 7  | Ø 24 mm | 781.24 |
| Fig. 8  | Ø 26 mm | 781.26 |
| Fig. 9  | Ø 28 mm | 781.28 |
| Fig. 10 | Ø 30 mm | 781.30 |

**RHODIUM**

|         |         |        |
|---------|---------|--------|
| Fig. 00 | Ø 8 mm  | 782.08 |
| Fig. 0  | Ø 10 mm | 782.10 |
| Fig. 1  | Ø 12 mm | 782.12 |
| Fig. 2  | Ø 14 mm | 782.14 |
| Fig. 3  | Ø 16 mm | 782.16 |
| Fig. 4  | Ø 18 mm | 782.18 |
| Fig. 5  | Ø 20 mm | 782.20 |
| Fig. 6  | Ø 22 mm | 782.22 |
| Fig. 7  | Ø 24 mm | 782.24 |
| Fig. 8  | Ø 26 mm | 782.26 |
| Fig. 9  | Ø 28 mm | 782.28 |
| Fig. 10 | Ø 30 mm | 782.30 |

plane, without handle



13.5 cm/5¼"

|         |         |        |
|---------|---------|--------|
| Fig. 00 | Ø 8 mm  | 785.08 |
| Fig. 0  | Ø 10 mm | 785.10 |
| Fig. 1  | Ø 12 mm | 785.12 |
| Fig. 2  | Ø 14 mm | 785.14 |
| Fig. 3  | Ø 16 mm | 785.16 |
| Fig. 4  | Ø 18 mm | 785.18 |
| Fig. 5  | Ø 20 mm | 785.20 |
| Fig. 6  | Ø 22 mm | 785.22 |
| Fig. 7  | Ø 24 mm | 785.24 |
| Fig. 8  | Ø 26 mm | 785.26 |
| Fig. 9  | Ø 28 mm | 785.28 |
| Fig. 10 | Ø 30 mm | 785.30 |

**RHODIUM**

|         |         |        |
|---------|---------|--------|
| Fig. 00 | Ø 8 mm  | 786.08 |
| Fig. 0  | Ø 10 mm | 786.10 |
| Fig. 1  | Ø 12 mm | 786.12 |
| Fig. 2  | Ø 14 mm | 786.14 |
| Fig. 3  | Ø 16 mm | 786.16 |
| Fig. 4  | Ø 18 mm | 786.18 |
| Fig. 5  | Ø 20 mm | 786.20 |
| Fig. 6  | Ø 22 mm | 786.22 |
| Fig. 7  | Ø 24 mm | 786.24 |
| Fig. 8  | Ø 26 mm | 786.26 |
| Fig. 9  | Ø 28 mm | 786.28 |
| Fig. 10 | Ø 30 mm | 786.30 |

**Larynx & Tonsils (Laryngeal Polypus Forceps)**

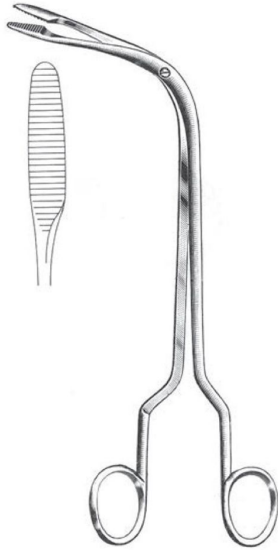

**FRAENKEL**  
**805.19**  
18 cm/7"

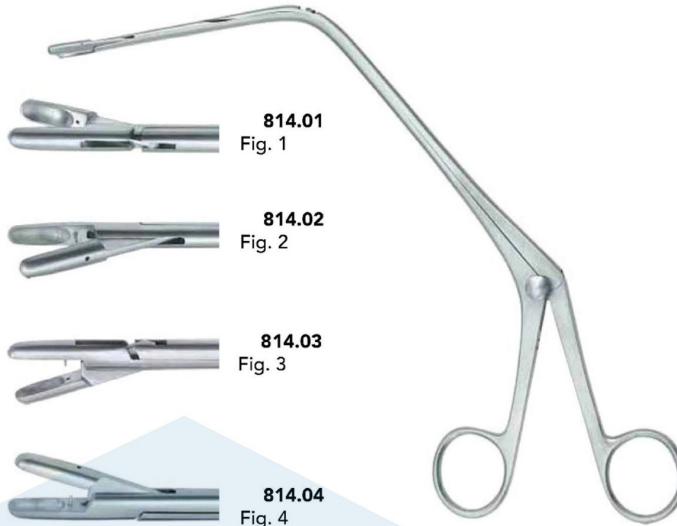

**814.01**  
Fig. 1

**814.02**  
Fig. 2

**814.03**  
Fig. 3

**814.04**  
Fig. 4

**JURASZ**  
23 cm/9"

Tampon forceps

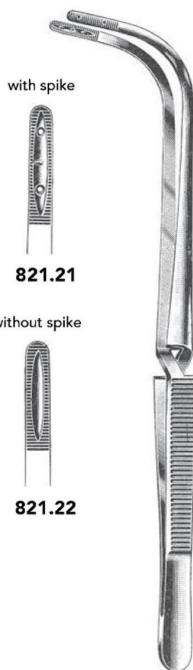

with spike

**821.21**

without spike

**821.22**

**JACKSON**  
22 cm/8¾"

Epiglottis Retractor



**REICHERT**  
**831.24**  
24 cm/9½"

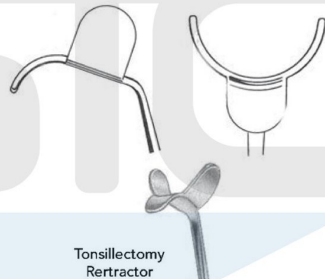

Tonsillectomy  
Retractor

**HOFER**  
**329.24**  
24 cm/9½"



Soft Plate  
Retractor

**NAGER**  
**331.23**  
24 cm/9"

**Larynx & Tonsils (Mouthgags & Tongue Depressors)**

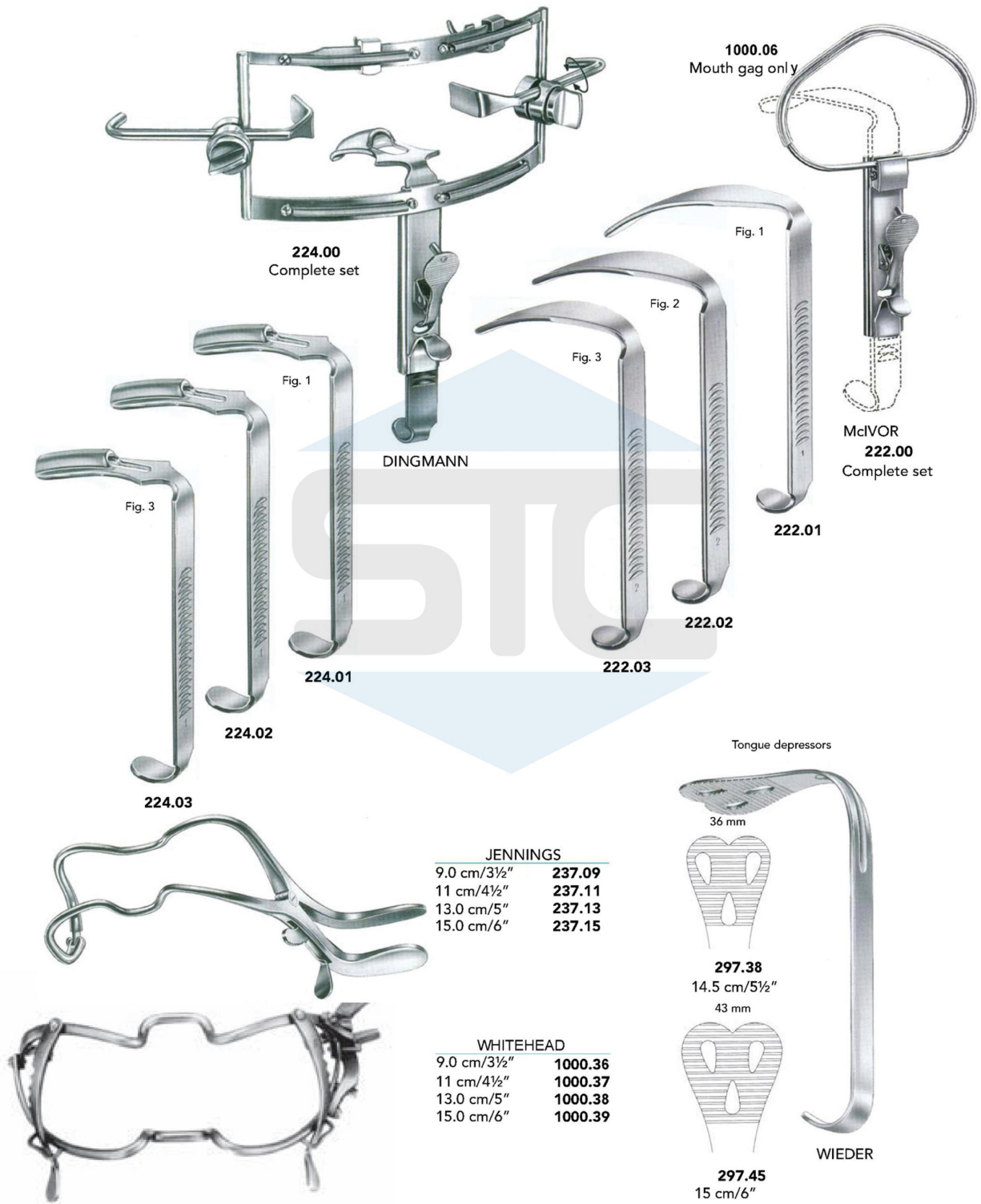

**224.00**  
Complete set

**1000.06**  
Mouth gag only

McVOR  
**222.00**  
Complete set

Fig. 1

Fig. 1

Fig. 2

Fig. 3

DINGMANN

**222.01**

Fig. 3

**222.02**

**224.01**

**222.03**

**224.02**

**224.03**

Tongue depressors

36 mm

| JENNINGS   |               |
|------------|---------------|
| 9.0 cm/3½" | <b>237.09</b> |
| 11 cm/4½"  | <b>237.11</b> |
| 13.0 cm/5" | <b>237.13</b> |
| 15.0 cm/6" | <b>237.15</b> |



**297.38**  
14.5 cm/5½"

| WHITEHEAD  |                |
|------------|----------------|
| 9.0 cm/3½" | <b>1000.36</b> |
| 11 cm/4½"  | <b>1000.37</b> |
| 13.0 cm/5" | <b>1000.38</b> |
| 15.0 cm/6" | <b>1000.39</b> |



**297.45**  
15 cm/6"

WIEDER

**Larynx & Tonsils (Mouthgags & Tongue Spatulas)**



1/2  
**KILNER-DOUGHTY**  
**1000.05**



1  
**DAVIS-BOYLE**  
**1000.09** Çocuklar için/For children  
**1000.10** Gençler için/For adolescents



1/2  
**DAVIS-BOYLE**  
**1000.35**  
Büyükler için/For adults



1/2  
**DOYEN-COLLIN**  
**1000.01**  
12 cm



1/2  
**DOYEN-JANSEN**  
**1000.02**  
14 cm



**1000.46**  
108 X 25 mm

**1000.45**  
92 X 25 mm

**1000.44**  
75 X 25 mm

**1000.43**  
62 X 25 mm



**1000.42**  
25 X 19 mm  
**DAVIS-BOYLE**

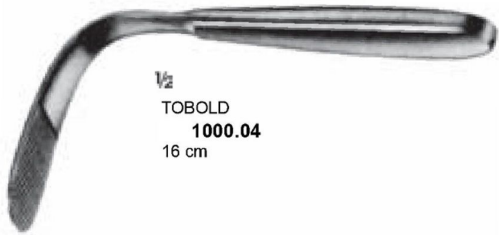

1/2  
**TOBOLD**  
**1000.04**  
16 cm



1/2  
**HARTMANN**  
**1000.07**  
15 cm



**Larynx & Tonsils (Mouthgags & Tongue Depressors)**



$\frac{1}{2}$   
**DENHARDT**  
**1000.48**  
Değiştirilebilir silikon parçalı  
Silicon inserts interchangeable  
12.5 cm



$\frac{1}{2}$   
**FERGUSSON-ACKLAND**  
**1000.49**  
14.5 cm



$\frac{1}{2}$   
**ROSER-KÖNIG**  
**1000.50**  
16 cm



$\frac{1}{2}$   
**ROSER-KÖNIG**  
**1000.51**  
18.5 cm

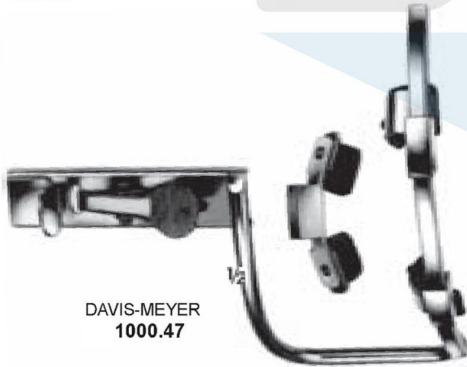

$\frac{1}{2}$   
**DAVIS-MEYER**  
**1000.47**



**1000.30**  
67 X 29 mm  
**1000.31**  
75 X 33 mm  
**1000.32**  
85 X 38 mm  
**1000.33**  
92 X 40 mm  
**1000.34**  
100 X 46 mm  
**RUSSEL-DAVIS**  
**1000.30 - 1000.31**

**Larynx & Tonsils (Mouthgags & Tongue Depressors)**

Tongue spatulas



**MOLT**  
**161.11**  
11 cm/5½"



**MOLT**  
**161.14**  
14 cm/5½"



**SCHMID**  
**1000.40**



**HEISTER**  
**1000.41**  
13 cm



**DOYEN**  
**375.13A** 23 x 30 mm  
13.5 cm/5¼"  
**375.13** 30 x 33 mm  
16 cm/6¼"

Cheek retractor

Swivel

35 mm

19 x 15 mm



**BRUENINGS**  
**385.19**  
19 cm/7½"



**350.16**  
16 cm/6¼"



**384.19**  
19 cm/7½"

24 x 27 mm

Tongue holding forceps



**COLLIN**  
**452.17**  
17 cm/6¾"

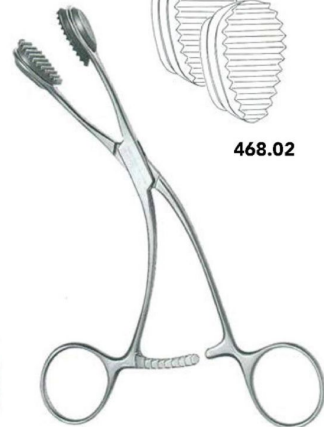

**YOUNG**  
**467.17**  
15 cm/6"

Pair Rubber Inserts

**468.02**

**Larynx & Tonsils (Tracheal Dilators & Tracheal Hooks)**



**LABORDE**  
**113.14**  
14 cm/5½"



**TROUSSEAU**  
**115.14**  
14.5 cm/5¾"



| ITERSON       |               |
|---------------|---------------|
| Sharp         | Blunt         |
| <b>125.16</b> | <b>127.16</b> |



**ROSE**  
**143.13**  
15.5 cm/6¼"



**LUER**  
**145.11**  
11 cm/4½"



| LAHEY       |               |
|-------------|---------------|
| 15.5 cm/6¼" | <b>449.15</b> |
| 20.0 cm/8"  | <b>449.20</b> |



**LUKENS**  
**151.17**  
11 cm/4¼"



**JACKSON**  
**155.17**  
18 cm/7¼"



**KOCHER**  
**411.15**  
15.5 cm/6¼"

with eye



**KOCHER**  
**413.15**  
15.5 cm/6¼"