

Gynecology (Vaginal Specula)



CUSCO	
110.01	75 x 32 mm
110.02	85 x 37 mm
110.03	100 x 35 mm
114.01	90 x 22 mm
114.02	100 x 25 mm
114.03	105 x 27 mm



CUSCO	
112.01	75 x 18 mm



SEYFFERT	
1000.04	100 x 17 mm
1000.05	100 x 33 mm
1000.06	110 x 33 mm (one side def.) 23 cm



CUSCO	
116.01	75 x 34 mm
116.02	85 x 37 mm
116.03	100 x 37 mm

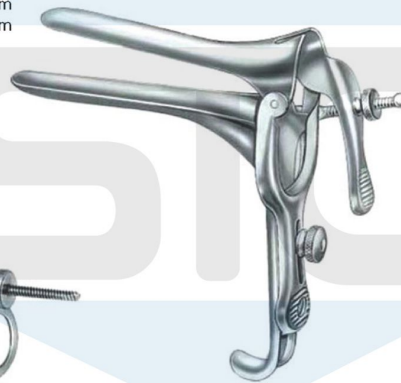

PEDERSON	
128.01	75 x 13 mm
128.02	100 x 24 mm
128.03	120 x 28 mm



GRAVE	
130.01	75 x 20 mm
130.02	95 x 35 mm
130.03	115 x 35 mm



COLLIN	
GY120.01 S	53 x 10 mm



COLLIN	
120.01	85 x 30 mm
120.02	100 x 35 mm
120.03	110 x 40 mm



SEMM	
132.01	100 x 20-25 mm
132.02	100 x 27-35 mm

Gynecology (Vaginal Specula & Retractors)



KRISTELLER			KRISTELLER			KRISTELLER		
182.01	70 x 27 mm	Fig. 1	183.01	70 x 23 mm	Fig. 1	185.01	Fig. 1	182.01), 183.01)
182.02	80 x 30 mm	Fig. 2	183.02	85 x 26 mm	Fig. 2	185.02	Fig. 2	182.02), 183.02)
182.03	90 x 36 mm	Fig. 3	183.03	100 x 32 mm	Fig. 3	185.03	Fig. 3	182.03), 183.03)



KRISTELLER			KRISTELLER			KRISTELLER		
190.01	105 x 18 mm	Fig. 1	191.01	110 x 14 mm	Fig. 1	195.01	Fig. 1	190.01), 191.01)
190.02	110 x 21 mm	Fig. 2	191.02	115 x 17 mm	Fig. 2	195.02	Fig. 2	190.02), 191.02)

Gynecology (Vaginal Specula & Retractors)



flat speculum

flat speculum

flat speculum

KRISTELLER

196.01	105 x 26 mm	Fig. 1
196.02	105 x 28 mm	Fig. 2
196.03	105 x 33 mm	Fig. 3

KRISTELLER

197.01	115 x 22 mm	Fig. 1
197.02	115 x 24 mm	Fig. 2
197.03	115 x 29 mm	Fig. 3

KRISTELLER

199.01	Fig. 1 (196.01), (197.01)
199.02	Fig. 2 (196.02), (197.02)
199.03	Fig. 3 (196.03), (197.03)



deep speculum

deep speculum

deep speculum

KRISTELLER

202.01	110 x 28 mm	Fig. 1
202.02	110 x 30 mm	Fig. 2
202.03	110 x 36 mm	Fig. 3

KRISTELLER

203.01	115 x 23 mm	Fig. 1
203.02	115 x 26 mm	Fig. 2
203.03	115 x 32 mm	Fig. 3

KRISTELLER

205.01	Fig. 1	202.01),	203.01)
205.02	Fig. 2	202.02),	203.02)
205.03	Fig. 3	202.03),	203.03)

Gynecology (Vaginal Specula & Retractors)



KALLMORGEN
232.01 70 x 40 mm Fig. 1
232.02 90 x 40 mm Fig. 2



KALLMORGEN
233.01 70 x 37 mm Fig. 1
233.02 90 x 37 mm Fig. 2



KALLMORGEN
235.01 Fig. 1 (232.01), (232.01)
235.02 Fig. 2 (232.02), (232.02)



SIMS
160.01 65 x 25 / 70 x 30 mm
160.02 65 x 25 / 80 x 35 mm
160.03 65 x 25 / 90 x 40 mm



JACKSON
165.01 75 x 38 mm
165.02 90 x 38 mm
165.03 100 x 38 mm



310.22
23.5 cm/9 1/4"
complete, with
detachable weight
310.90
Weight only

AUVARD

Gynecology (Vaginal Specula & Retractors)



DOYEN

249.01	58 x 35 mm
249.02	88 x 35 mm
249.03	118 x 35 mm
250.01	60 x 47 mm
250.02	78 x 47 mm
250.03	120 x 47 mm
250.04	165 x 47 mm
251.01	55 x 60 mm
251.02	85 x 60 mm
251.03	115 x 60 mm

BREISKY

323.20	100 x 20 mm	29.5 cm/11½"
323.25	100 x 25 mm	29.5 cm/11½"
323.30	100 x 30 mm	29.5 cm/11½"
323.35	100 x 35 mm	29.5 cm/11½"
323.40	100 x 40 mm	29.5 cm/11½"
324.20	130 x 20 mm	32.0 cm/12¾"
324.25	130 x 25 mm	32.0 cm/12¾"
324.30	130 x 30 mm	32.0 cm/12¾"
324.35	130 x 35 mm	32.0 cm/12¾"
324.40	130 x 40 mm	32.0 cm/12¾"
325.40	160 x 40 mm	35.0 cm/14"

DOYEN

342.24	25 cm/10"
--------	-----------

70 x 30 mm

U U

Gynecology (Endocervical Specula, Uterine Dilators)



KOGAN
381.24
24.5 cm/9½"

Endocervical Specula



KOGAN
383.24
24.5 cm/9½"



GOODELL
383.34
34 cm/13½"

Uterine Dilators

Gynecology (Uterine Dilators)



HEGAR
18.5 cm / 7 1/4"

	Diameter		Diameter
400.01	Ø 1.0 mm	401.01	Ø 1.5 mm
400.02	Ø 2.0 mm	401.02	Ø 2.5 mm
400.03	Ø 3.0 mm	401.03	Ø 3.5 mm
400.04	Ø 4.0 mm	401.04	Ø 4.5 mm
400.05	Ø 5.0 mm	401.05	Ø 5.5 mm
400.06	Ø 6.0 mm	401.06	Ø 6.5 mm
400.07	Ø 7.0 mm	401.07	Ø 7.5 mm
400.08	Ø 8.0 mm	401.08	Ø 8.5 mm
400.09	Ø 9.0 mm	401.09	Ø 9.5 mm
400.10	Ø 10.0 mm	401.10	Ø 10.5 mm
400.11	Ø 11.0 mm	401.11	Ø 11.5 mm
400.12	Ø 12.0 mm	401.12	Ø 12.5 mm
400.13	Ø 13.0 mm	401.13	Ø 13.5 mm
400.14	Ø 14.0 mm	401.14	Ø 14.5 mm
400.15	Ø 15.0 mm	401.15	Ø 15.5 mm
400.16	Ø 16.0 mm	401.16	Ø 16.5 mm
400.17	Ø 17.0 mm	401.17	Ø 17.5 mm
400.18	Ø 18.0 mm		
400.19	Ø 19.0 mm		
400.20	Ø 20.0 mm	400.80	set of 14 pieces (full sizes) from 4,0 to 17,0 mm without case
400.21	Ø 21.0 mm	400.84	set of 14 pieces (full sizes) from 4,0 to 17,0 mm in metal case
400.22	Ø 22.0 mm	400.90	set of 26 pieces (full sizes) from 1,0 to 26,0 mm without case
400.23	Ø 23.0 mm	400.98	metal case only, for Ø 4-17 mm
400.24	Ø 24.0 mm		
400.25	Ø 25.0 mm		
400.26	Ø 26.0 mm		



HEGAR
20 cm / 8"

	Diameter
430.02	Ø 1,0 / 2,0 mm
430.04	Ø 3,0 / 4,0 mm
430.06	Ø 5,0 / 6,0 mm
430.08	Ø 7,0 / 8,0 mm
430.10	Ø 9,0 / 10 mm
430.12	Ø 11 / 12 mm
430.14	Ø 13 / 14 mm
430.16	Ø 15 / 16 mm
430.18	Ø 17 / 18 mm
430.20	Ø 19 / 20 mm
430.22	Ø 21 / 22 mm
430.24	Ø 23 / 24 mm
430.26	Ø 25 / 26 mm



430.82 (Set of 8)
(Ø 3.0 / 4.0 to Ø 17.0 / 18.0 mm)
in canvas roll

430.80 (Set of 8)
(Ø 3.0 / 4.0 to Ø 17.0 / 18.0 mm)
without canvas roll

430.86 (Set of 13)
(Ø 1.0 / 2.0 to Ø 25 / 26 mm)
with canvas roll

Gynecology (Uterine Dilators)

American scale

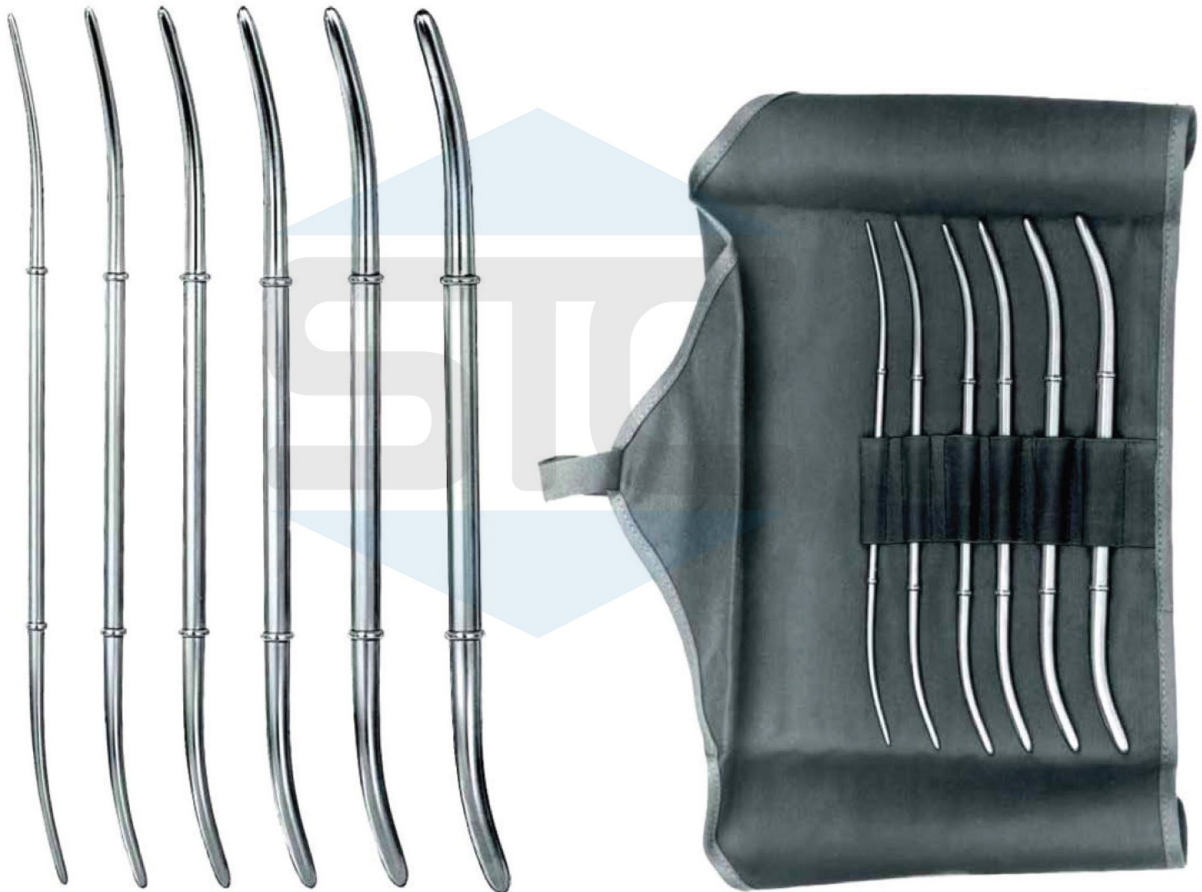

HANK
26.5 cm/10½"

	Diameter	Fig
460.10	Ø 4.5 / 5.0 mm	9 / 10
460.12	Ø 5.5 / 6.0 mm	11 / 12
460.14	Ø 6.5 / 7.0 mm	13 / 14
460.16	Ø 7.5 / 8.0 mm	15 / 16
460.18	Ø 8.5 / 9.0 mm	17 / 18
460.20	Ø 9.5 / 10 mm	19 / 20

460.82
set of 6 Pieces in boilable canvas roll

Gynecology (Uterine Sounds, Uterine Depressor)

Ø 4 mm
rigid



SIMS
583.32
33 cm/13"

Ø 4 mm
malleable



SIMS
584.32
33 cm/13"

Ø 4 mm



VALLEIX
593.25
27 cm/10½"

Uterine Depressor



BRAUN
596.26
27 cm/10½"

Gynecology (Uterine Tenaculum Forceps, Amniotome)



SCHROEDER
622.25
25 cm/10"



BRAUN
628.25
25 cm/10"



DUPLAY
645.28
28 cm/11"



BEACHAM
659.26
26 cm/10¼"

Gynecology (Uterine Tenaculum Forceps)

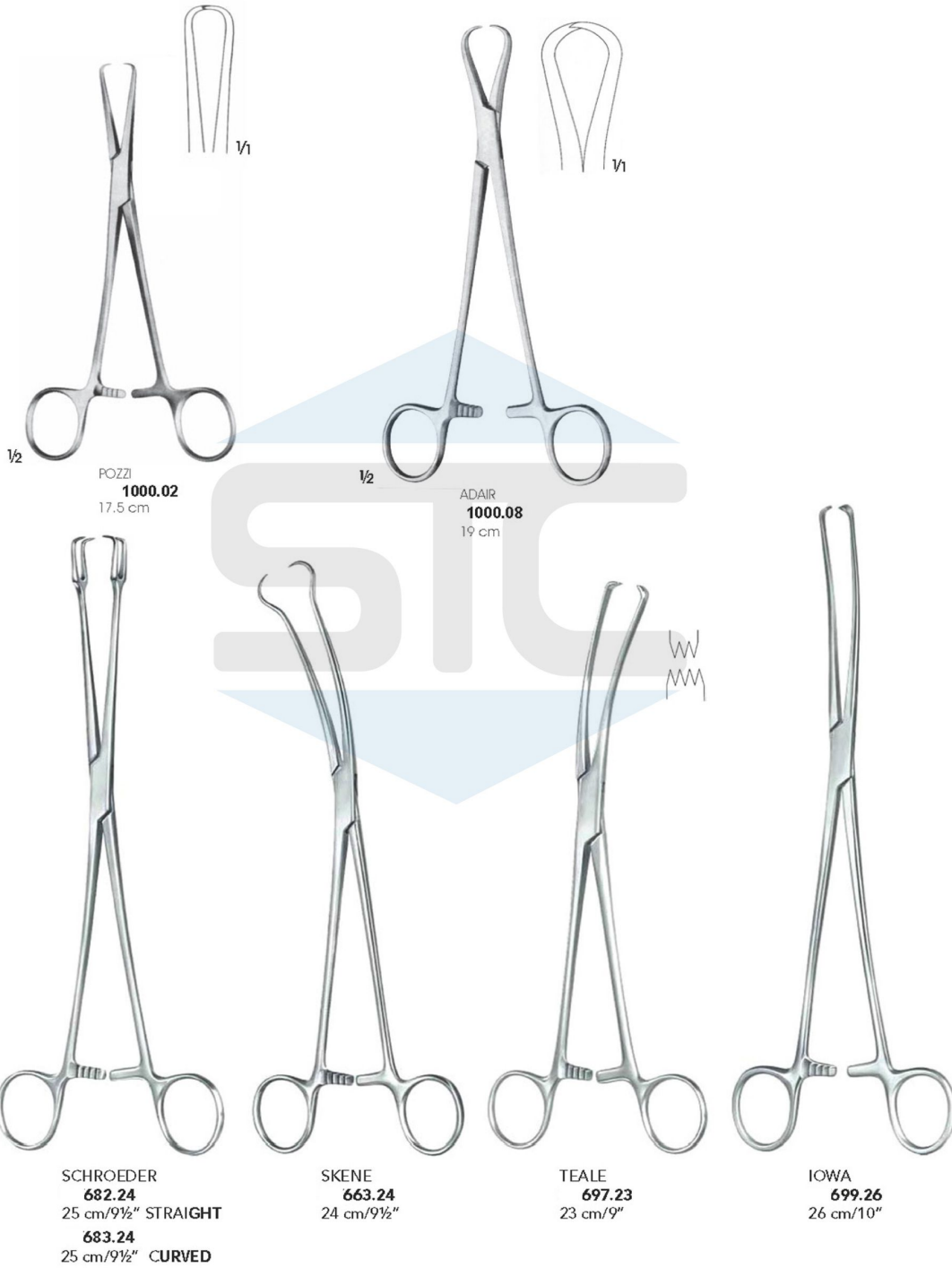

Gynecology (Uterine Tenaculum Forceps)

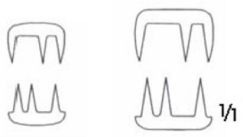

1000.09
26 cm

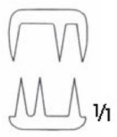

1000.10



702.24
7 mm



704.24
9 mm



706.24
10 mm

4 x 4

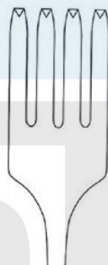

4 x 4



4 x 4

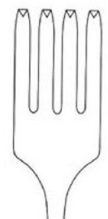

MUSEUX
24 cm/9½"



734.26
26.5 cm/10½"



CZERNY
740.21
21 cm/8¼"



BRAUN
738.16
16 cm/6¼"

Gynecology (Uterine Polypus Forceps)



JACOBS
728.21
21 cm/8¼"

KELLY
741.32
31.5 cm/12¾"

NOTO
744.27
27 cm/10½"

HEYWOOD-SMITH
745.25
26 cm/10¼"
1000.01
20 cm/8"

Gynecology (Uterine Seizing Forceps)

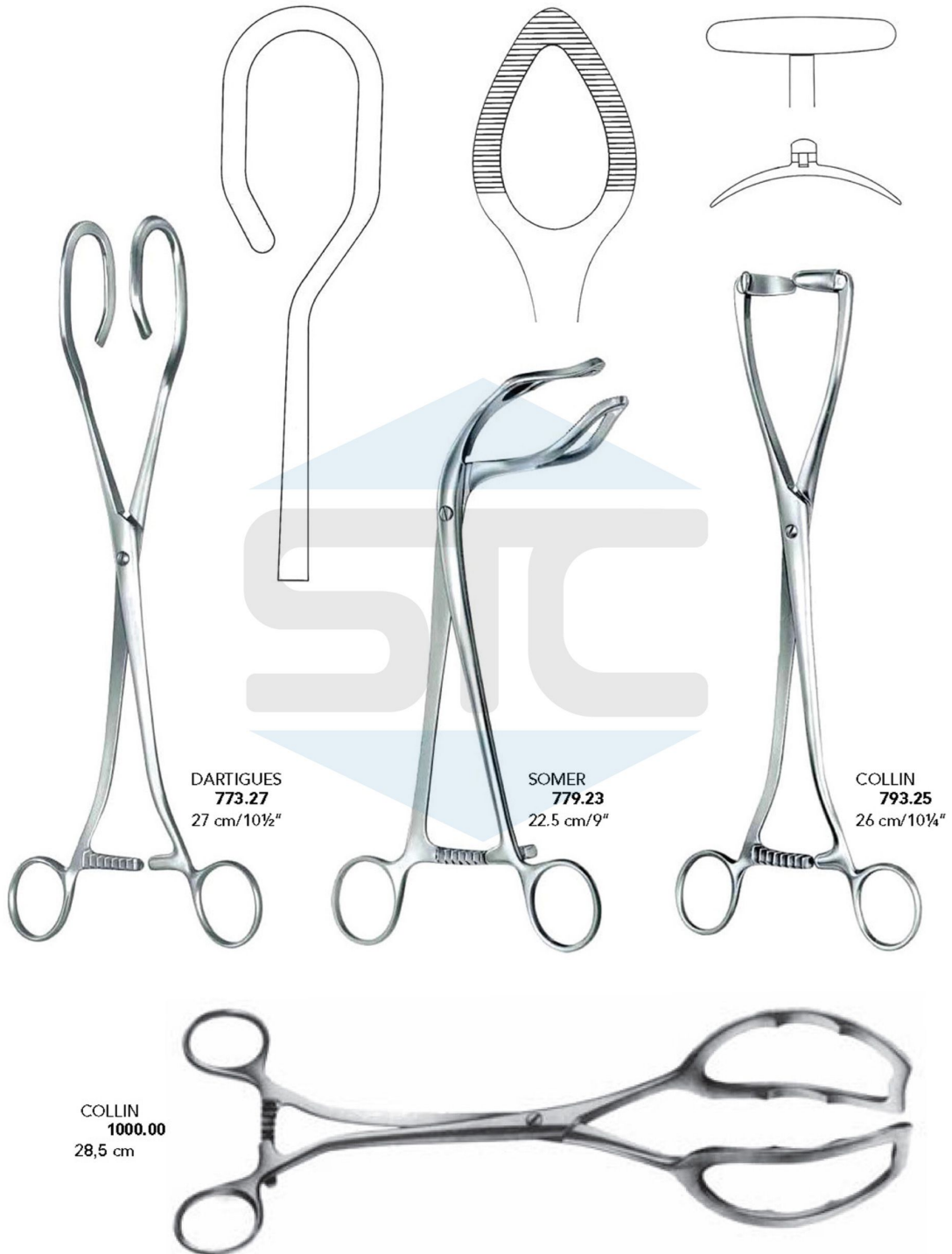

Gynecology (Fistula Hooks, Suction Curettes)

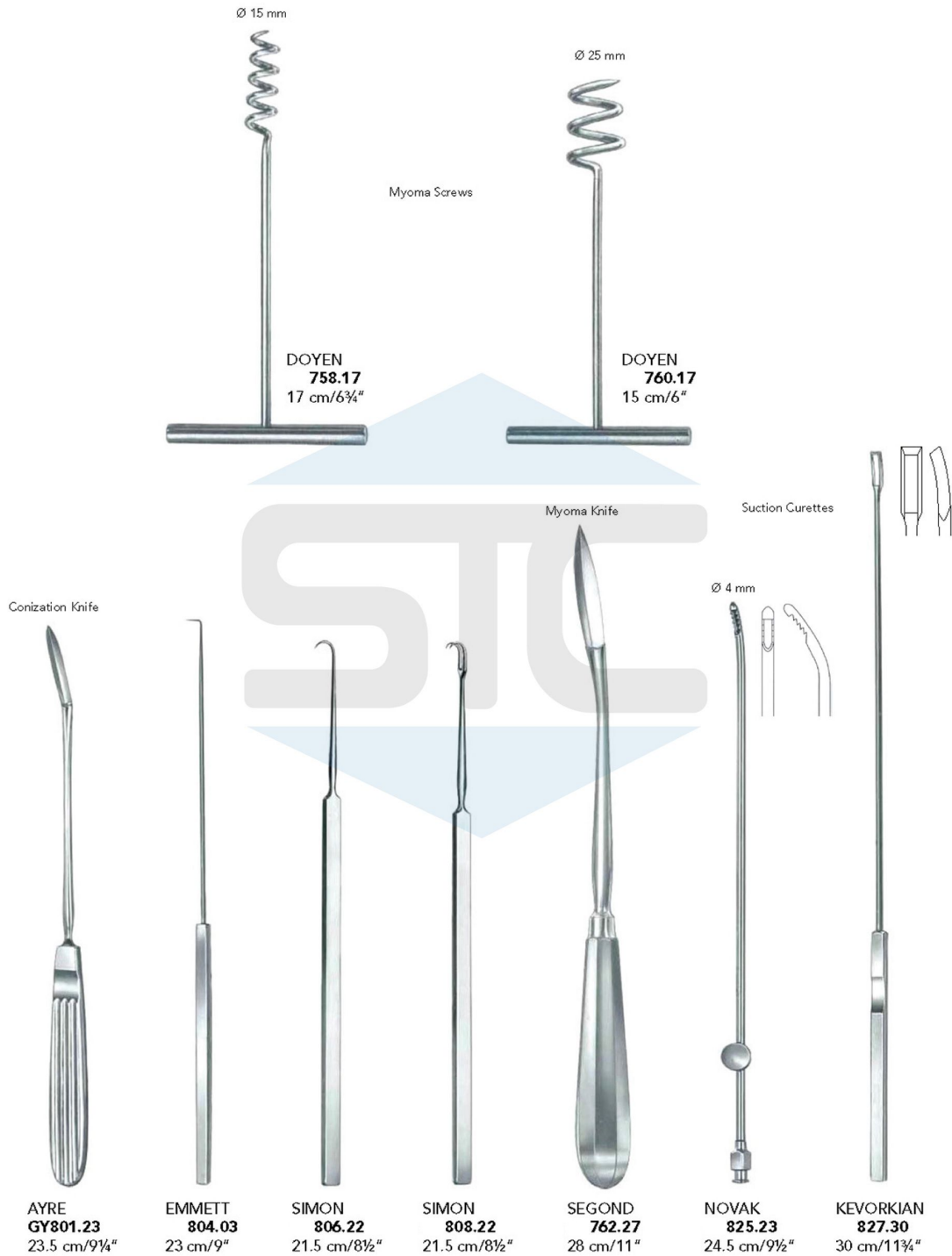

Gynecology (Uterine Biopsy Forceps)



1000.15



1000.16



SCHUMACHER
1000.15-GY1000.16
24 cm



GELLHORN
841.23
24 cm/9½"

FAURE
843.21
21 cm/8¼"

SCHUBERT
846.21 21.5 cm/8½"
846.28 28.0 cm/11"

THOMS-GAYLOR
851.22 21 cm/8¼"
851.24 24.0 cm/9"

Gynecology (Uterine Biopsy Forceps)



Gynecology (Uterine Biopsy Forceps, IUP Grasping Forceps)

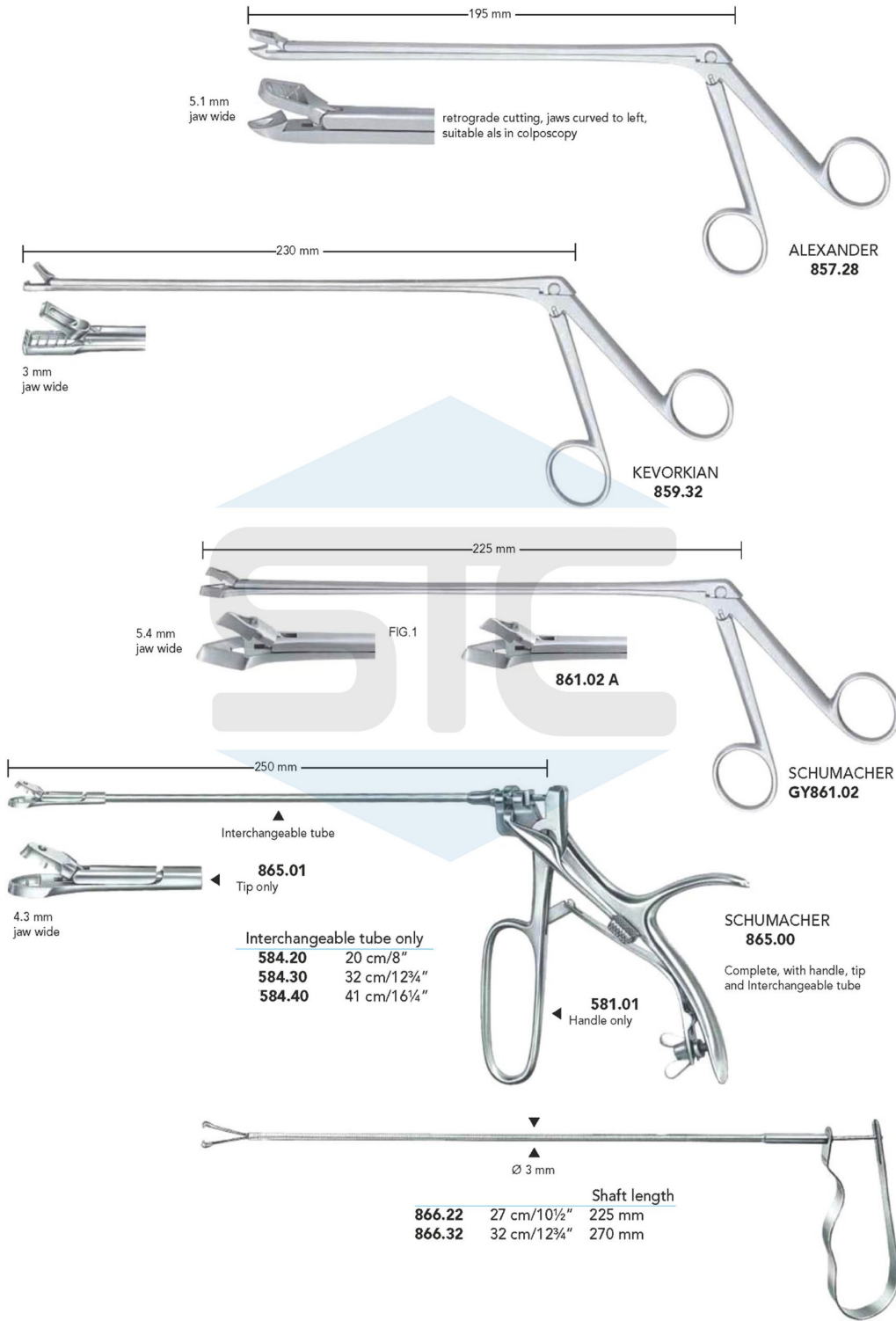

Gynecology (Uterine Scoops, Uterine Curettes)



SIMON
23.5 cm/9¼"

Fig. 1	900.01	10 x 7 mm
Fig. 2	900.02	12 x 8 mm
Fig. 3	900.03	13 x 10 mm
Fig. 4	900.04	16 x 12 mm
Fig. 5	900.05	18 x 13 mm
Fig. 6	900.06	20 x 15 mm



SIMON
24 cm/9½"

906.01	10 x 7 mm
906.02	12 x 8 mm
906.03	13 x 10 mm
906.04	16 x 12 mm
906.05	18 x 13 mm
906.06	20 x 15 mm



BLAKE
919.00
27.5 cm/10¾"



GREENE
28 cm/11"
924.10 10 mm
924.12 12 mm
924.14 14 mm

Suction Curettes



989.50
11 cm/4¼"

989.03	29 cm/11¾"	Ø 3.0 mm
989.04		Ø 4.5 mm
989.06		Ø 6.0 mm
989.08		Ø 8.0 mm
989.10		Ø 10 mm
989.12		Ø 12 mm
989.14		Ø 14 mm

Gynecology (Uterine Curettes)

RECAMIER

Fig.	Tip width	Sharp, rigid	Sharp, malleable
00	5 mm	920.05	921.05
0	6 mm	920.06	921.06
1	7 mm	920.07	921.07
2	8 mm	920.08	921.08
3	9 mm	920.09	921.09
4	11 mm	920.11	921.11
5	12 mm	920.12	921.12
6	14 mm	920.14	921.14
7	15 mm	920.15	921.15
8	16 mm	920.16	921.16
9	19 mm	920.19	921.18
10	20 mm	920.20	921.20
11	21 mm	920.21	921.21
12	23 mm	920.23	921.23
13	25 mm	920.25	921.25
14	30 mm	920.30	921.30
15	35 mm	920.35	921.35
16	40 mm	920.40	921.40

sharp, rigid

sharp, malleable

blunt, rigid

blunt, malleable



SIMS

Fig.	Tip width	Blunt, rigid	Blunt, malleable
00	5 mm	926.05	927.05
0	6 mm	926.06	927.06
1	7 mm	926.07	927.07
2	8 mm	926.08	927.08
3	9 mm	926.09	927.09
4	11 mm	926.11	927.11
5	12 mm	926.12	927.12
6	14 mm	926.14	927.14
7	15 mm	926.15	927.15
8	16 mm	926.16	927.16
9	19 mm	926.19	927.19
10	20 mm	926.20	927.20
11	21 mm	926.21	927.21
12	23 mm	926.23	927.23
13	25 mm	926.25	927.25
14	30 mm	926.30	927.30
15	35 mm	926.35	927.35
16	40 mm	926.40	927.40

RECAMIER
920.05-
920.40

RECAMIER
921.05-
921.40

SIMS
926.05-
926.40

SIMS
927.05-
927.40

Gynecology (Obstetrical Forceps)



NAEGELE
36.5 cm/14½" **141.36**
40.5 cm/16¼" **141.40**



SIMPSON
145.30
30.5 cm/12"



WRIGLEY
146.28
28 cm/11"



SIMPSON
149.36
36.5 cm/14¾"



KIELLAND
195.41
41 cm/16½"



KIELLAND-LUIKART
197.40
40 cm/16"



PIPER
198.44
44.5 cm/17¾"



Pelvimeter

103.34
35 cm/14"

Obstetrical Lever



SELLHEIM
309.28
32 cm/12¾"

Umbilical Clamps



COLLIN
465.09
8.5 cm/3½"

Gynecology (Placenta & Ovum Forceps, Placenta Scoops)

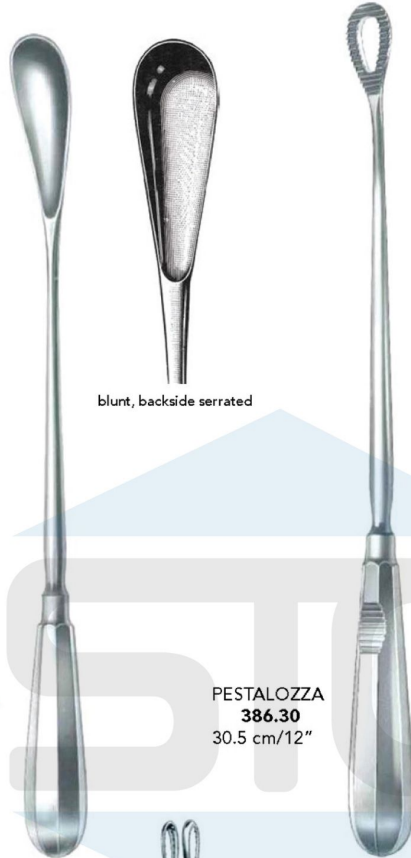

blunt, backside serrated

CUZZI
30 cm/12" **382.01**
30 cm/12" **382.02**
30 cm/12" **382.03**

PESTALOZZA
386.30
30.5 cm/12"

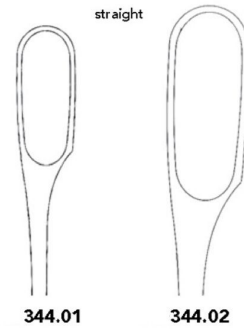

straight

344.01

344.02



Uterine Clamp

GREEN-ARMYTAGE
300.21
21 cm/8¼"

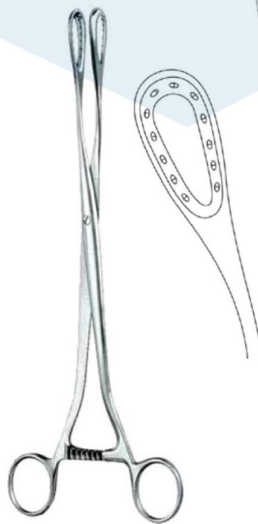

SAENGER
27.5 cm/10¾"
228.27 Straight
229.27 Curved



WINTER
28 cm/11"

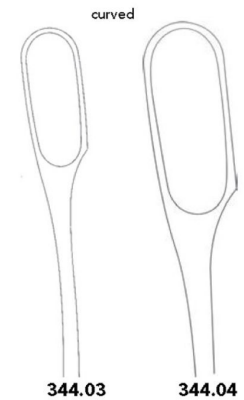

curved

344.03

344.04