

Bone Surgery (Bone Chisels, Gouges, Osteotomes)

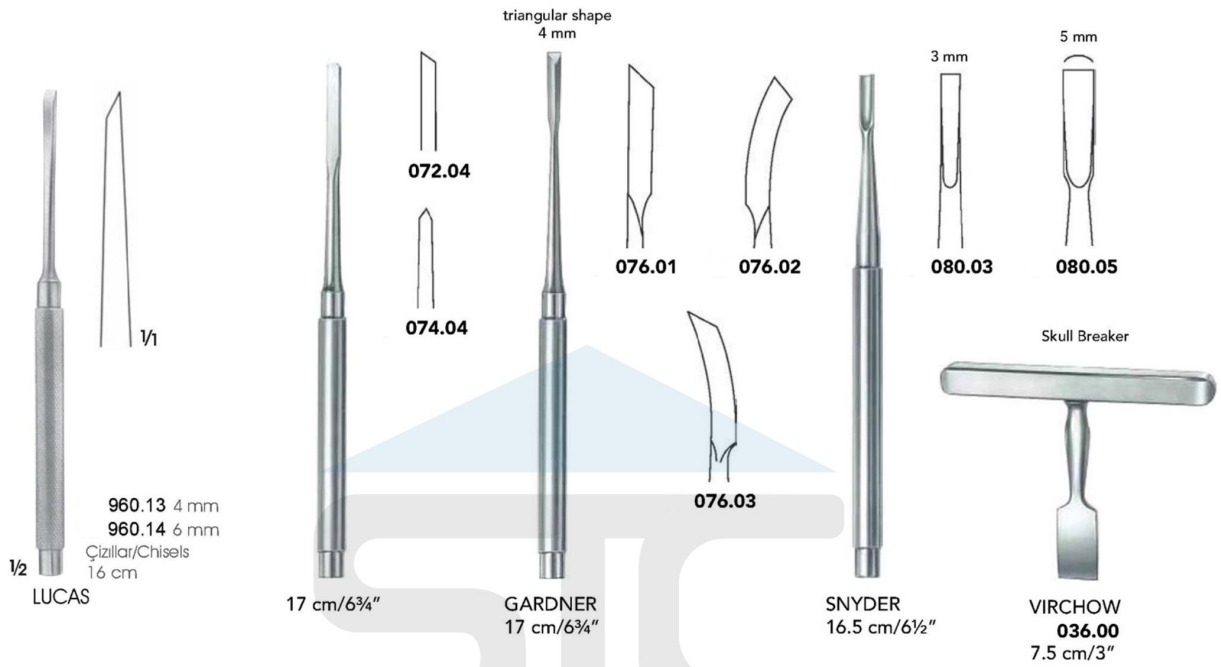

	13.5 cm/5 1/4"			PARTSCH		13.5 cm/5 1/4"		16.5 cm/6 1/2"	
8 mm	100.08	101.08	102.08	2 mm	105.02	106.02	109.02	110.02	
10 mm	100.10	101.10	102.10	3 mm	105.03	106.03	109.03	110.03	
12 mm	100.12	101.12	102.12	4 mm	105.04	106.04	109.04	110.04	
14 mm	100.14	101.14	102.14	5 mm	105.05	106.05	109.05	110.05	
16 mm	100.16	101.16	102.16	6 mm	105.06	106.06	109.06	110.06	

Bone Surgery (Bone Chisels, Gouges, Osteotomes)

ALEXANDER
17.5 cm/7"

4 mm	118.04	119.04
6 mm	118.06	119.06
8 mm	118.08	119.08
10 mm	118.10	119.10
12 mm	118.12	119.12
14 mm	118.14	119.14

STILLE
20.5 cm

8 mm	123.10	124.08	125.10	127.10
10 mm	123.12	124.12	125.12	127.12
12 mm	123.15	124.15	125.15	127.15
15 mm	123.20	124.20	125.20	127.20
20 mm	123.25	124.25	125.25	127.25
25 mm				

STILLE
20.5 cm/8"

8 mm	124.08	125.10	127.10
10 mm	124.12	125.12	127.12
12 mm	124.15	125.15	127.15
15 mm	124.20	125.20	127.20
20 mm	124.25	125.25	127.25
25 mm			

LAMBOTTE-MINI
12.5 cm/5"

2 mm	136.02
3 mm	136.03
4 mm	136.04
6 mm	136.06
8 mm	136.08
10 mm	136.10
12 mm	136.12
15 mm	136.15

LAMBOTTE-MINI
17.5 cm/7"

3 mm	136.53
4 mm	136.54
6 mm	136.56
8 mm	136.58
10 mm	136.60
12 mm	136.62
15 mm	136.65

LAMBOTTE
24 cm/9½"

4 mm	138.04
6 mm	138.06
8 mm	138.08
10 mm	138.10
13 mm	138.13
15 mm	138.15
18 mm	138.18
20 mm	138.20
25 mm	138.25
30 mm	138.30
38 mm	138.38
44 mm	138.44
50 mm	138.50

LAMBOTTE
24 cm/9½"

4 mm	139.04
6 mm	139.06
8 mm	139.08
10 mm	139.10
13 mm	139.13
15 mm	139.15
18 mm	139.18
20 mm	139.20
25 mm	139.25
30 mm	139.30
38 mm	139.38
44 mm	139.44
50 mm	139.50

Bone Surgery (Bone Chisels, Gouges, Osteotomes)



SMITH-PETERSEN
20.5 cm/8"

6 mm	154.06
9 mm	154.09
13 mm	154.13
16 mm	154.16
19 mm	154.19
25 mm	154.25
32 mm	154.32



155.06
155.09
155.13
155.16
155.19
155.25
155.32



SMITH-PETERSEN
20.5 cm/8"

9 mm	156.09
14 mm	156.16
19 mm	156.19
25 mm	156.25



157.09
157.16
157.19
157.25



HOKE
17 cm/6¾"

3 mm	162.03
5 mm	162.05
6 mm	162.06
8 mm	162.08
9 mm	162.09



HIBBS
24.5 cm/9¾"

6 mm	170.06
13 mm	170.13
19 mm	170.19
25 mm	170.25
32 mm	170.32



172.06
172.13
172.19
172.25
172.32



173.06
173.13
173.19
173.25
173.32



176.06
176.13
176.19
176.25
176.32



177.06
177.13
177.19
177.25
177.32

Bone Surgery (Osteotomes, Gouges)



Bone Surgery (Osteotomes, Gouges, Bone Currettes)

LEXER
22 cm/8¾"

5 mm	134.05
7 mm	134.07
10 mm	134.10
15 mm	134.15
20 mm	134.25
25 mm	134.20
30 mm	134.30

LEXER
22 cm/8¾"

5 mm	135.05
7 mm	135.07
10 mm	135.10
15 mm	135.15
20 mm	135.25
25 mm	135.20
30 mm	135.30

LEXER-MINI
18 cm/7"

4 mm	132.04
6 mm	132.06
8 mm	132.08
10 mm	132.10
12 mm	132.12

LEXER-MINI
18 cm/7"

4 mm	133.04
8 mm	133.06
8 mm	133.08
10 mm	133.10
12 mm	133.12

VOLKMANN

Fig.	17 cm/7"	27 cm/10¾"
0000	280.40	
000	280.30	
00	280.20	
0	280.10	282.10
1	280.01	282.01
2	280.02	282.02
3	280.03	282.03
4	280.04	282.04
5	280.05	
6	280.06	

CASPER
22 cm/8¾"

Ø 3 mm	197.03
Ø 5 mm	197.05
Ø 7 mm	197.07
Ø 8 mm	197.08
Ø 9 mm	197.09

20 cm/8"

Ø 12 mm	199.12
Ø 14 mm	199.14
Ø 16 mm	199.16

PASSOW
960.81-82
12 cm

960.81	3.5 mm
960.82	2.5 mm

15.5 cm/6"

Ø 2 mm	198.02
Ø 3 mm	198.03
Ø 4 mm	198.04
Ø 5 mm	198.05
Ø 6 mm	198.06
Ø 7 mm	198.06
Ø 8 mm	198.08
Ø 9 mm	198.08
Ø 10 mm	198.10

Bone Surgery (Mallets)

WILLIGER
24 cm/9½"

Ø 26 mm	275g	200.01
Ø 28 mm	320g	200.02
Ø 30 mm	340g	200.03

DOYEN
20.5 cm/8¼"

Ø 25 mm	120g	204.01
Ø 30 mm	170g	204.02
Ø 35 mm	260g	204.03

COLLIN
208.20
20 cm/7¾"

LUCAE
19.5 cm/7¾"

Ø 19 mm	230g	214.01
Ø 25 mm	260g	214.02

COTTLE
215.19
19 cm/7½"

OMBREDANNE
960.56
24 cm

WILLIGER
216.01
16.5 cm/6½"

MEAD
220.17
19 cm/7½"

PARTSCH
224.18
19 cm/7½"

HAJEK
960.21
135 gr.
20 cm

960.22
155 gr
19 cm

960.43
24 cm

140g
Ø 20 mm

450g
Ø 30 mm

175g
Ø 27 mm

Ø 27 mm

Ø 22

Ø 30 mm

Ø 42 mm
285 gr

220g
Ø 30 mm

30C
Ø 30 mm

Ø 40 mm
520 gr

221.00
Spare facing pair

Bone Surgery (Mallets)



Bone Surgery (Bone Curettes)



SCHEDE
Fig. 17 cm/7"

000	300.30
00	320.20
0	300.10
1	301.01
2	301.02
3	301.03
4	301.04

VOLKMANN
Fig. 17 cm/7"

0000	304.40
000	304.30
00	304.20
0	304.10
1	305.01
2	305.02
3	305.03
4	305.04
5	305.05
6	305.06

BRUNS
Fig. 17 cm/7"

0000	308.40
000	308.30
00	308.20
0	308.10
1	339.01
2	339.02
3	339.03
4	339.04
5	339.05
6	339.06

BRUNS
Fig. 17 cm/7"

000	960.65
00	960.66
0	960.67
1	960.68
2	960.69
3	960.70
4	960.71

SPRATT
Fig. 20 cm

0000	312.40
000	312.30
00	312.20
0	312.10
1	313.01
2	313.02
3	313.03
4	313.04
5	313.05

SPRATT
Fig. 20 cm

0000	960.72
000	960.73
00	960.74
0	960.75
1	960.76
2	960.77
3	960.78
4	960.79
5	960.80



DAUBENSPECK
Fig. 17 cm/7"

0000	306.40
000	306.30
00	306.20
0	306.10



MODELL USA
Fig. 16.5 cm/6½"

1	344.01
2	344.02
3	344.03
4	344.04
5	344.05
6	344.06



MODELL USA
Fig. 16.5 cm/6½"

1	345.01
2	345.02
3	345.03
4	345.04
5	345.05
6	345.06



MODELL USA
Fig. 16.5 cm/6½"

1	347.01
2	347.02
3	347.03
4	347.04
5	347.05
6	347.06





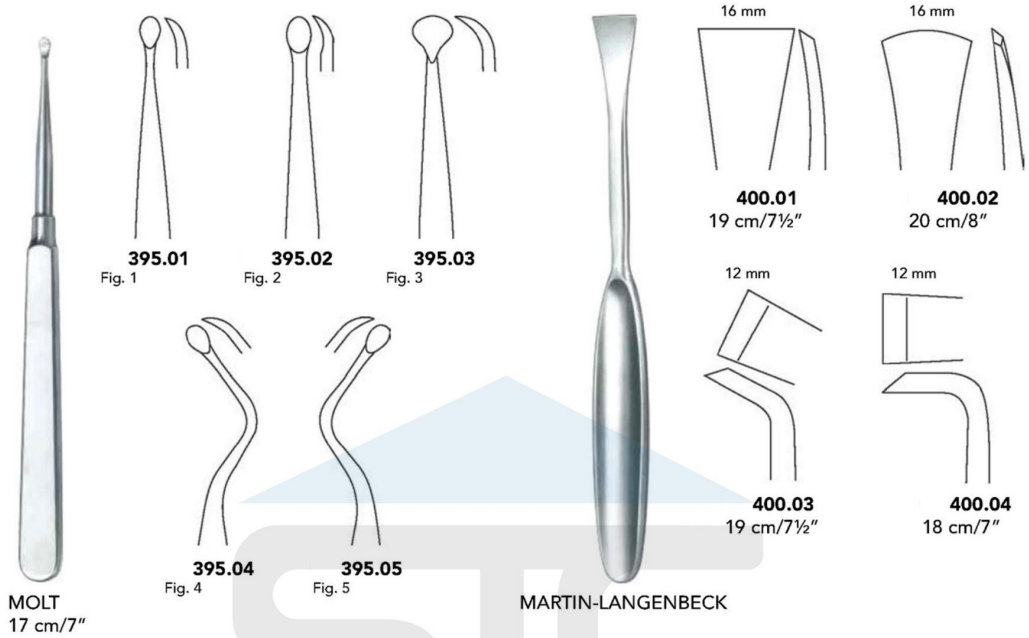

HALLE
Fig. 25 cm/9¾"

1	350.01
2	350.02
3	350.03

Bone Surgery (Periosteal Elevators)



Periosteal Elevators

				
MARTIN-HOEN	MARTIN-CUSHING	MARTIN-CUSHING	LANGENBECK	LANGENBECK
19 cm/6¼" 7 mm 400.10	17.5 cm/6¾" 4 mm 400.20	17 cm/6¾" 400.30	18 cm/7" 401.18	19 cm/7½" 402.19
18.5 cm/7¼" 15 mm 400.11	17.5 cm/6¾" 6 mm 400.21			
19 cm/7½" 20 mm 400.12	19.5 cm/7¾" 5 mm 400.25			
	19.5 cm/7¾" 7 mm 400.26			

Bone Surgery (Periosteal Elevators)

<p>4.5 mm</p>  <p>LANDOLT 404.18 17.5 cm/6¾"</p>	<p>15 mm</p>  <p>JANSEN 405.17 16.5 cm/6½"</p>	<p>5 mm</p>  <p>KOENIG 406.16 15.5 cm/6"</p>	<p>8 mm</p>  <p>TRELAT 407.15 15 cm/6"</p>	<p>13 mm</p>  <p>SCHNEIDER 408.18 17.5 cm/6¾"</p>	<p>13 mm</p>  <p>SCHNEIDER-SAUERBRUCH 409.14 19 cm/7½"</p>	<p>delicate, angled, solid</p>  <p>COTTLE 412.20 19 cm/7½"</p>	<p>16 cm/6¼"</p> <table border="0"> <tr> <td>5 mm</td> <td>411.05</td> </tr> <tr> <td>6 mm</td> <td>411.06</td> </tr> <tr> <td>7 mm</td> <td>411.07</td> </tr> </table>	5 mm	411.05	6 mm	411.06	7 mm	411.07			
5 mm	411.05															
6 mm	411.06															
7 mm	411.07															
<p>6 mm</p>  <p>SEWALL 413.20 20 cm/8"</p>	<p>18 mm</p>  <p>SEDILLOT 414.19 18.5 cm/7¼"</p>	<p>11 mm</p>  <p>FARABEU-F-COLLIN 15.5 cm/6¼"</p> <table border="0"> <tr> <td>Straight</td> <td>416.11</td> </tr> <tr> <td>Curved</td> <td>417.11</td> </tr> </table>	Straight	416.11	Curved	417.11	<p>12.5 mm</p>  <p>FARABEU 15.5 cm/6¼"</p> <table border="0"> <tr> <td>Straight</td> <td>418.15</td> </tr> <tr> <td>Curved</td> <td>419.15</td> </tr> </table>	Straight	418.15	Curved	419.15	<p>4 mm</p>  <p>MÜHLING 17 cm/6¾"</p>	<p>421.01</p> 	<p>421.02</p> 	<p>421.03</p> 	<p>421.04</p> 
Straight	416.11															
Curved	417.11															
Straight	418.15															
Curved	419.15															

Bone Surgery (Periosteal Elevators)



KEY

18 cm/7¼"	3 mm	423.01
18 cm/7¼"	6 mm	423.02
19 cm/7½"	10 mm	423.03
19 cm/7½"	13 mm	423.04
20 cm/8"	16 mm	423.05
20 cm/8"	19 mm	423.06
21 cm/8¼"	25 mm	423.07



COBB

	23 cm/9"	28 cm/11"
6 mm	426.06	425.06
10 mm	426.10	425.10
13 mm	426.13	425.13
19 mm	426.19	425.19
25 mm	426.25	425.25



SEDILLOT
427.21
23 cm/9"



KAHRE-WILLIGER
16.5 cm/6½"



4 mm
436.04



5 mm
436.05

7 mm



WILLIGER
436.07
16 cm/6¼"

6 mm



WILLIGER
434.13
12.5 cm/5"

5 mm



WILLIGER
436.16
16 cm/6¼"



17 cm/7"

3 mm	438.03
6 mm	438.06



17 cm/7"

6 mm	439.06
8 mm	439.08

Bone Surgery (Periosteal Elevators)



DOYEN

Right Curved

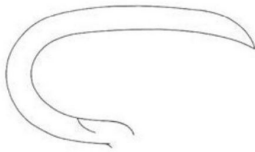

441.17
17 cm/6¾"

Left Curved



443.17
17 cm/6¾"

Right Curved



445.17
18 cm/7"

Left Curved



447.17
18 cm/7"



ALEXANDER
448.21
21 cm/8¼"

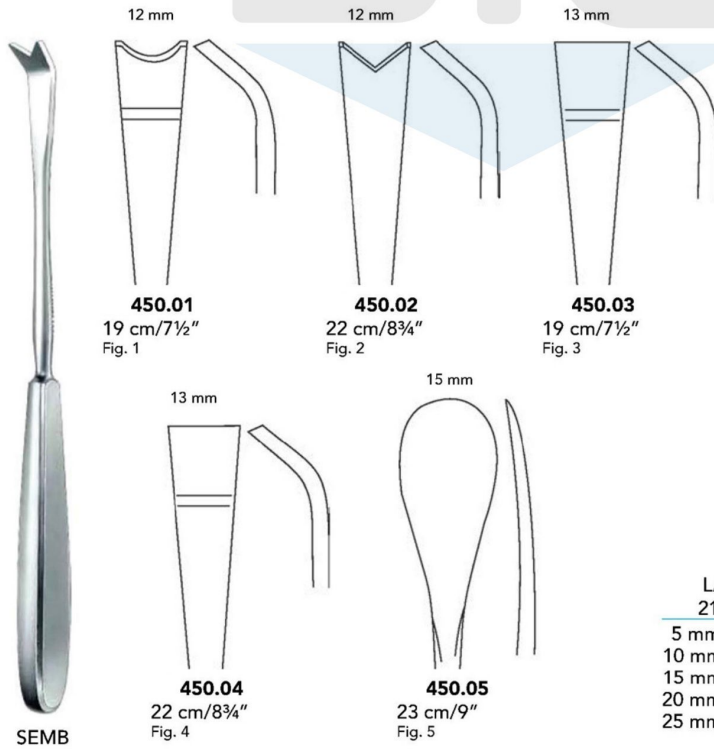

SEMB

12 mm



450.01
19 cm/7½"
Fig. 1

12 mm

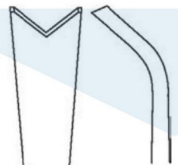

450.02
22 cm/8¾"
Fig. 2

13 mm



450.03
19 cm/7½"
Fig. 3

13 mm

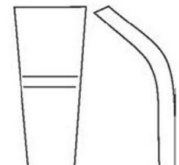

450.04
22 cm/8¾"
Fig. 4

15 mm



450.05
23 cm/9"
Fig. 5

LAMBOTTE
21.5 cm/8½"

5 mm	461.05
10 mm	461.10
15 mm	461.15
20 mm	461.20
25 mm	461.25



Bone Surgery (Bone Files & Elevators)



479.28
28 cm/11"



481.24
25 cm/9¾"

flat solid



482.22
22 cm/8¾"



PUTTI
181.30
30 cm/11¾"



PUTTI
183.27
27 cm/10½"



ADSON
17.5 cm/7"



484.17



485.17



486.17



487.17

downwards cutting



MILLER-COLBURN
18 cm/7"



490.01
Fig. 1

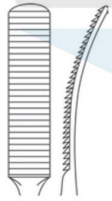

490.02
Fig. 2

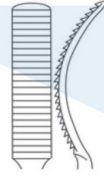

490.03
Fig. 3

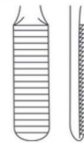

490.04
Fig. 4

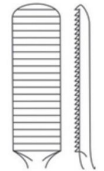

490.05
Fig. 5



TC Jaws



MILLER
19 cm/7½"



492.01

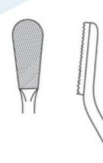

493.03



cross cutting



MILLER-COLBURN
Fig. 18 cm/7"

- 1 **491.01**
- 2 **491.02**
- 3 **491.03**
- 4 **491.04**

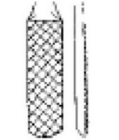
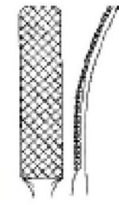

Bone Surgery (Elevators & Bone Levers)



LANGENBECK

19.5 cm/7¾"	7 mm	495.20
19.5 cm/7¾"	10 mm	497.20
23 cm/9"	11 mm	498.23



WILLIGER
510.17
17 cm/7"



WILLIGER
513.16
16 cm/6¼"



SEBILEAU
516.18
17.5 cm/7"



QUERVAIN
517.20
19.5 cm/7¾"



ALDERDYCE
525.21
21 cm/8¼"



MCDONALD
527.19
18.5 cm/7¼"

2.8 mm

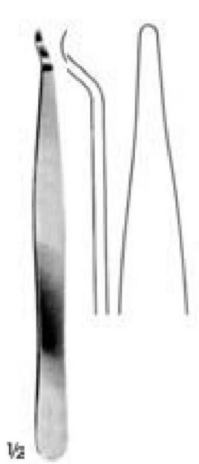

960.63
14 cm

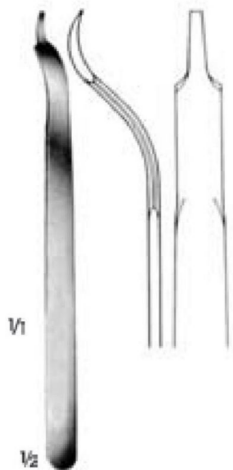

BUCK-GRAMCKO
960.62
15 cm

2 mm



537.06
15 cm/6"



HOHMANN, MINI
16 cm/6¾"

6 mm	539.06
8 mm	539.08

15 mm



539.15
16 cm/6¾"

12 cm	539.16
15 mm	



BENNETT

24 cm/9½"	43 mm	559.24
23.5 cm/9¼"	60 mm	561.24

Bone Surgery (Bone Levers)

Knee Retractors

39 mm



BLOUNT
563.26
26.5 cm/10½"

47 mm



BLOUNT
565.26
26.5 cm/10½"

8 mm



HOHMANN
541.08
21.5 cm/8¾"

18 mm



HOHMANN
541.18
23.5 cm/9½"

43 mm



HOHMANN
541.43
23.5 cm/9½"

70 mm



HOHMANN
541.70
25 cm/9¾"

43 mm



HOHMANN
543.43
23.5 cm/9½"

22 mm



HOHMANN
545.22
25.5 cm/10¼"

35 mm



HOHMANN
545.35
29 cm/11½"

24 mm



HOHMANN
547.24
27.5 cm/10¾"

22 mm



LANGE-HOHMANN
549.22
25 cm/9¾"

Bone Surgery (Spinal Retractors, Meniscus Knives, Tendon Strippers)

960.32
Ø 2 mm

960.33
Ø 3 mm

960.34
Ø 4 mm

960.35
Ø 6 mm

960.37
Ø 4 mm

960.38
Ø 4.5 mm

960.39
Ø 5.5 mm

BUNNELL
13.5 cm

TAYLOR
16 cm/6¼"

571.16
95 x 30 mm

573.16
115 x 30 mm

Esnek shaft/Flexible shaft
23 cm

BLOUNT
567.17
17.5 cm/6¾"

630.17
Fig. 1

631.17
Fig. 2

633.17
Fig. 3

NEFF
22 cm/8¾"

SALENIUS
21.5 cm/8½"

FISCHER
660.31
31 cm/12¼"

662.29
28.5 cm/11¼"

BUNNELL
664.23
23 cm/9"

Tendon Passer

Bone Surgery (Tendon Holding Forceps, Tendon Tunnelling Forceps)

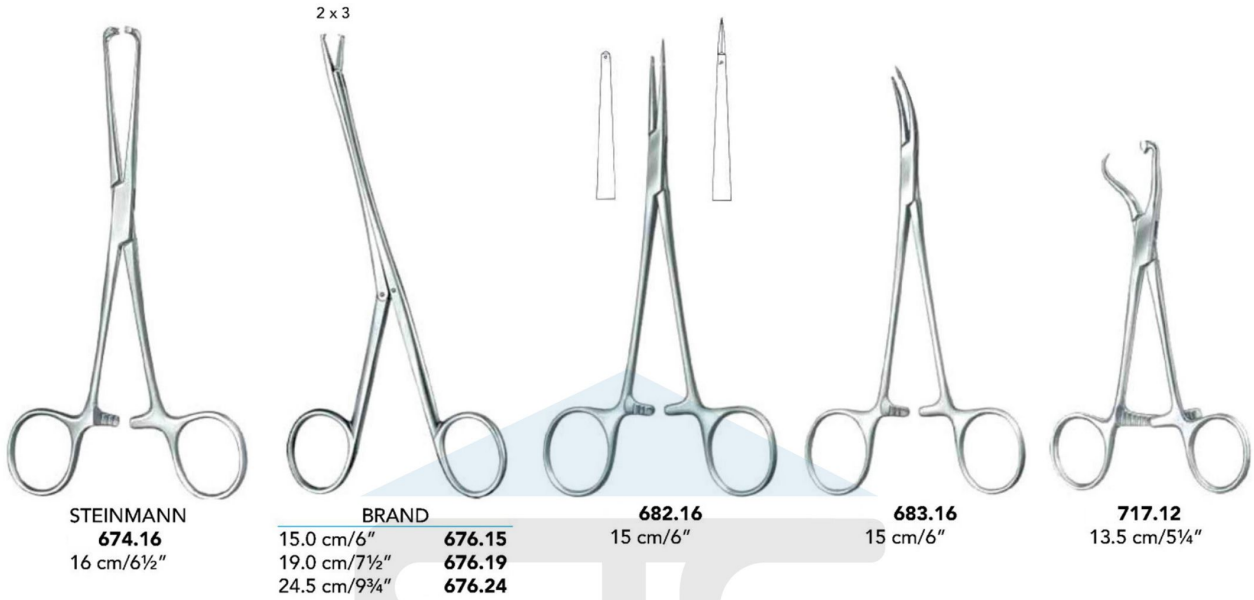

Bone holding forceps



Bone Surgery (Tendon Holding Forceps, Tendon Tunnelling Forceps)



2:3
21.0 cm/8¼"
Straight Curved
678.00 678.01



LEWIN
718.17
18 cm/7"



MARTIN
716.19
18.5 cm/7¼"

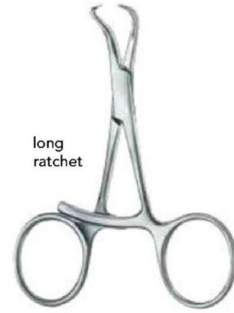

long ratchet

OB721.09
14 cm/5½"

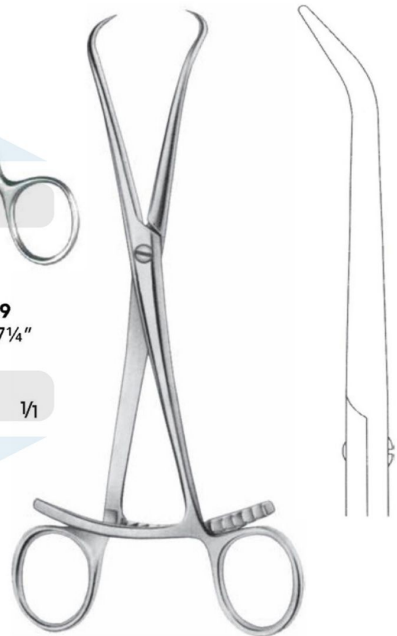

960.28
Pozisyon pensi
Reposition forceps
20.5 cm



DINGMANN
715.19
18.5 cm/7¼"

Bone holding forceps



721.14
14 cm/5½"

long ratchet



716.14
14 cm/5½"

delicate



CARROLL
679.11
11.5 cm/4½"

Bone Surgery (Bone Holding Forceps)



LANGENBECK
722.21
21 cm/8¼"



FERGUSSON
724.21
21 cm/8¼"



FROSCH
726.18
18 cm/7"



727.20
20 cm/8"



729.16
17.5 cm/7"



729.24
17.5 cm/7"



KERN
17.0 cm/6¾" **730.17**
24.5 cm/9¾" **730.21**



SEMB
731.19
19.5 cm/7¾"



732.23
23 cm
734.26
26 cm/10¼"

Bone Surgery (Bone Holding Forceps)



with thread fixation

ULRICH

	Straight	Angled
23 cm/9"	746.23	747.23
25 cm/10"	746.25	747.25
28 cm/11"	746.28	747.28



1/2 VERBRUGGE
960.61
17.5 cm



VERBRUGGE

25 cm/10"	755.01
26 cm/10 1/4"	755.02
27.5 cm/10 3/4"	755.03



LANE
33 cm/13"

With Ratchet	Without Ratchet
750.33	752.33

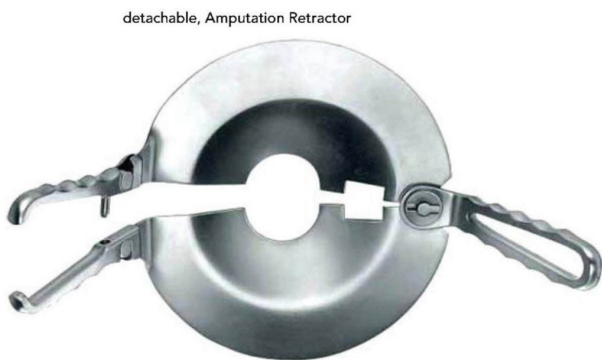

detachable, Amputation Retractor

PERCEY
762.30



LOWMAN

16 cm	960.29
18 cm	960.30
20 cm	960.31

Bone Surgery (Bone Rongeurs)



STELLBRINK



FRIEDMANN
799.12
12.5 cm/4¾"



FRIEDMANN
801.14
13.5 cm/5¼"



FRIEDMANN
803.14
13.5 cm/5¼"



CLEVELAND
805.14
13.5 cm/5¼"



CLEVELAND
807.17
16.5 cm/6½"



MEAD
815.16
16.5 cm/6½"



MEAD
816.16
16.5 cm/6½"



HARTMANN
819.18
17.5 cm/7"



LUER
18.0 cm/7"
Straight **846.17**
Curved **847.17**

Bone Surgery (Bone Rongeurs)



JANSEN

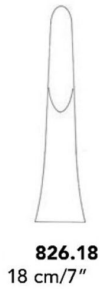

BLUMENTHAL
16.0 cm/7"

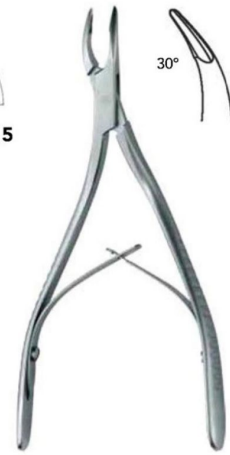
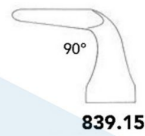
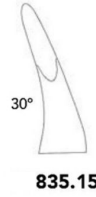

835.30
15.5 cm/6"



836.00
15.5 cm/6"



836.30
15.5 cm/6"



836.90
14.5 cm/5¾"

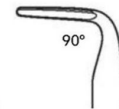

ZAUFAL-JANSEN
881.30
18 cm/7"

Bone Surgery (Bone Rongeurs)



BEYER
879.18
18 cm/7"



MAYFIELD
883.17
18 cm/7"



MARQUARD
885.20
20.5 cm/8"



RUSKIN
887.18
19 cm/7½"



LEMPERT
19 cm/7½"
Straight **832.19** Curved **833.19**



LUER
14.5 cm/5¾"



853.15

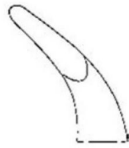

864.15



BOEHLER ½
15 cm/6"
Straight **876.15** Curved **877.15**



OLIVECRONA
960.54
20.5 cm

Bone Surgery (Bone Rongeurs)

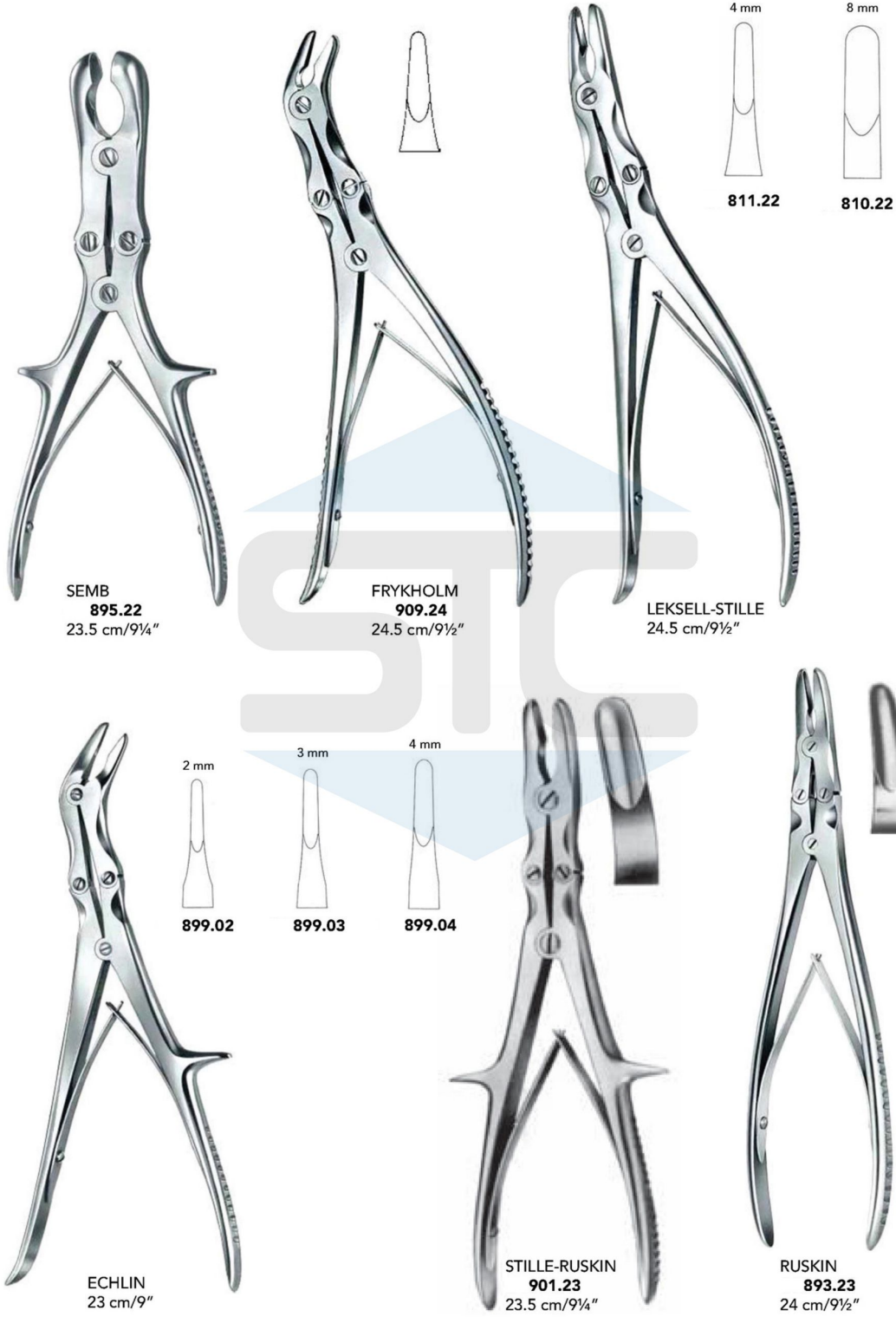

Bone Surgery (Bone Rongeurs)

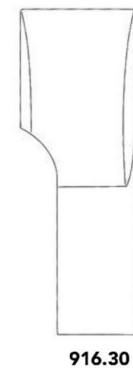
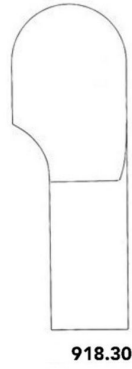

Bone Surgery (Bone Cutting Forceps)



COTTLE-KAZANJIAN
930.19
19 cm/7½"

Straight



LISTON
14 cm/5½" **934.14**
17 cm/6¾" **934.17**
20 cm/8" **934.19**
22 cm/8¾" **934.22**

Curved



LISTON
14 cm/5½" **935.14**
17 cm/6¾" **935.17**
20 cm/8" **935.19**
22 cm/8¾" **935.22**



CLEVELAND
939.17
17 cm/7"

Straight



CLEVELAND
941.15
14.5 cm/5¾"

Curved



BOEHLER
944.15
14.5 cm/5¾"



BOEHLER
946.15
14.5 cm/5¾"



CLEVELAND
947.16
17 cm/7"



950.18



951.18



RUSKIN-LISTON
17 cm/7"

Bone Surgery (Bone Cutting Forceps)



SEMB
959.24
24.5 cm/19³/₄"



STILLE-LISTON
952.27
17 cm/7"



STILLE-LISTON
23.5 cm/10³/₄" **955.23**
28 cm/11" **955.27**



STILLE-LISTON
954.27
28 cm/11"



LISTON-KEY
957.27
26 cm/10³/₄"

Bone Surgery (HAND SAWS)

BIER
960.23 Komple/Complete
42 cm
Length blade
Bleyd uzunluđu
27 cm

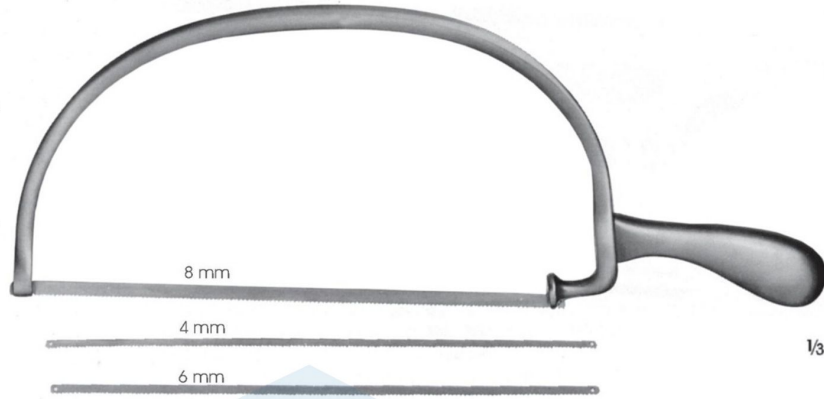

CHARRIERE
960.24 Komple/Complete
35 cm

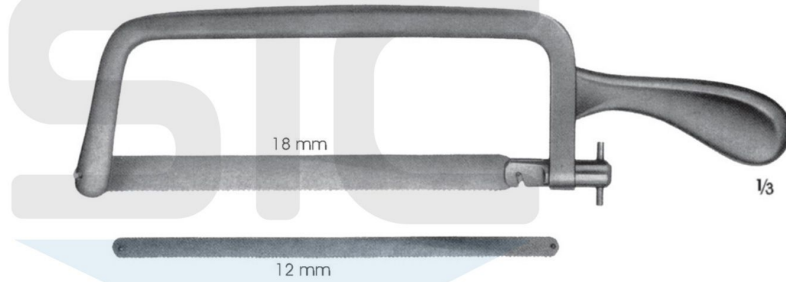

CHARRIERE
960.25 27 cm
960.26 34 cm



SATTERLEE
960.27
29 cm

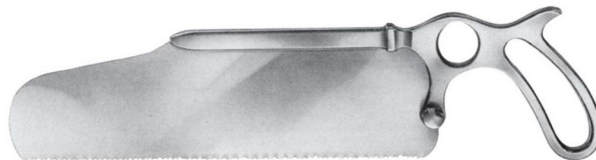

Bone Surgery (Wire Bender Pliers & Extractors)



960.57
Tırıllı ağız
With serrated jaws

Tel bükücü, düz burunlu
wire twister, flat nosed
17 cm

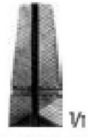

960.41
Boylamasına ve
çapraz kanallı
With longitudinal
and transversal
grooves



960.42
Tel tutma pensi, düz burunlu
Wire holding forceps, flat nosed
19 cm



MARBURG MODELL
960.64
Tel tutma pensi,
Düz burunlu, tırıllı ağız
Wire holding forceps,
Flat nosed, with serrated jaws
1.4 cm



960.53
Çıkartıcı/Extractor
25 cm



961.53
Çıkartıcı/Extractor
27 cm



960.56A
Parmak yüzük testere
Finger ring saw
15 cm

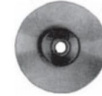

960.56B
Yedek bıyık
Spare blade



960.55
STAPLER SÖKÜCÜ
STAPLER REMOVER
9 cm

Bone Surgery (Wire Cutting Pliers & Nippers)



Flat nose pliers

505.17
17 cm/6¾"



507.18
18 cm/7"



Flat nose plier



Hackstock
518.16
16 cm/6¼"

Wire nipper



MARTIN-Diamant
522.16
16 cm/6¼"

Side-cutting plier

Extracting forceps



511.01
18 cm/7"

TC Jaws



523.22
22 cm/8¾"

TC Jaws

Combination cutting plier



526.18
22 cm/8¾"

TC Jaws

Wire twisting forceps



500.20
20 cm/8"

Bone Surgery (Wire Cutting Pliers & Nippers)



Bone Surgery (Bending Pliers, Plate Cutter)



Bending press

229.30

Bending pliers for small plates



229.22
22 cm/8¾"

Plate bending plier



124.16
16 cm/6¼"

Plate bending plier



229.20

Plate cutter



528.55
55 cm/22"

Bone Surgery (Gauges, Measuring Sleeves, Drill Bit Guides)



Bone Surgery (Wire Traction Bows)

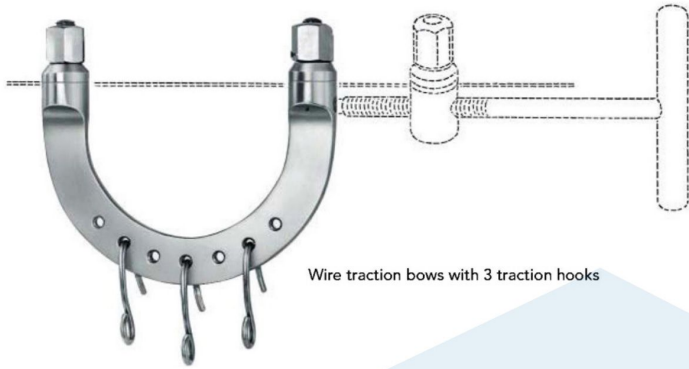

KIRSCHNER	
95 x 70 mm	581.01
105 x 105 mm	581.02
120 x 120 mm	581.03
155 x 155 mm	581.04



KIRSCHNER	
18.5 cm/7¼"	585.01
26.5 cm/10¼"	585.02



180 x 100 mm	589.18
270 x 160 mm	589.27

Bone Surgery (Hand Drills, Wire Traction Bows)

Ø 4 mm



Steinmann Pins, with trocar tip
 14 cm/5½" **562.14**
 16 cm/6¼" **562.16**
 18 cm/7" **562.18**
 20 cm/8" **562.20**

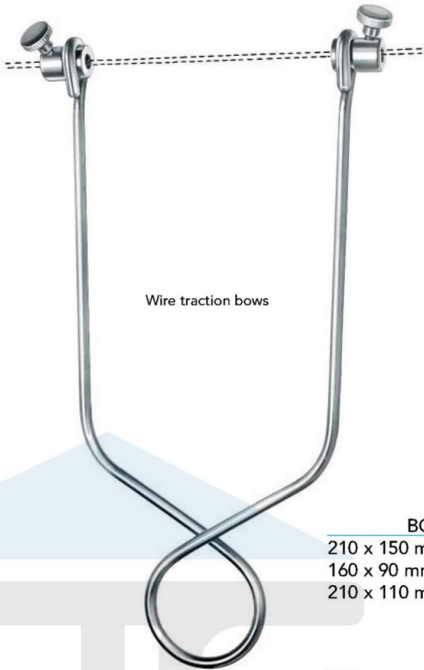

Wire traction bows

BOEHLER

210 x 150 mm **565.15**
 160 x 90 mm **565.16**
 210 x 110 mm **565.21**

with three jaw chuck, longitudinal bore



BUNNEL
606.00

with three jaw chuck and pin key



Wrench

620.99

with three jaw chuck



RALK
611.01



620.05

Handle with three jaw chuck, with key

Ayarlı sap
Adjustable handle



1000.03
El matkabı/Hand drill only
28 cm



Anahtar/Key

Bone Surgery (Screw Drivers)



Bone Surgery (Hand Surgery)

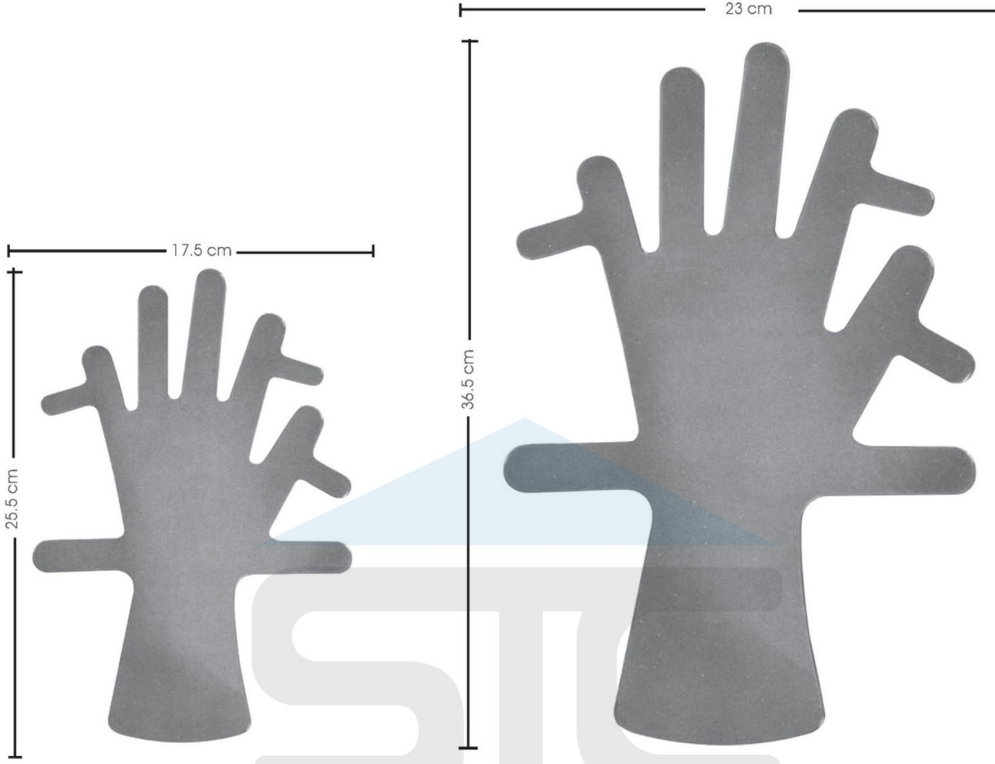

960.58
Çocuklar için el sabitleyici, yumuşak
Children's hand control, soft

960.59
Yetişkinler için el sabitleyici, yumuşak
Used stabilizer for adults, soft



960.60